

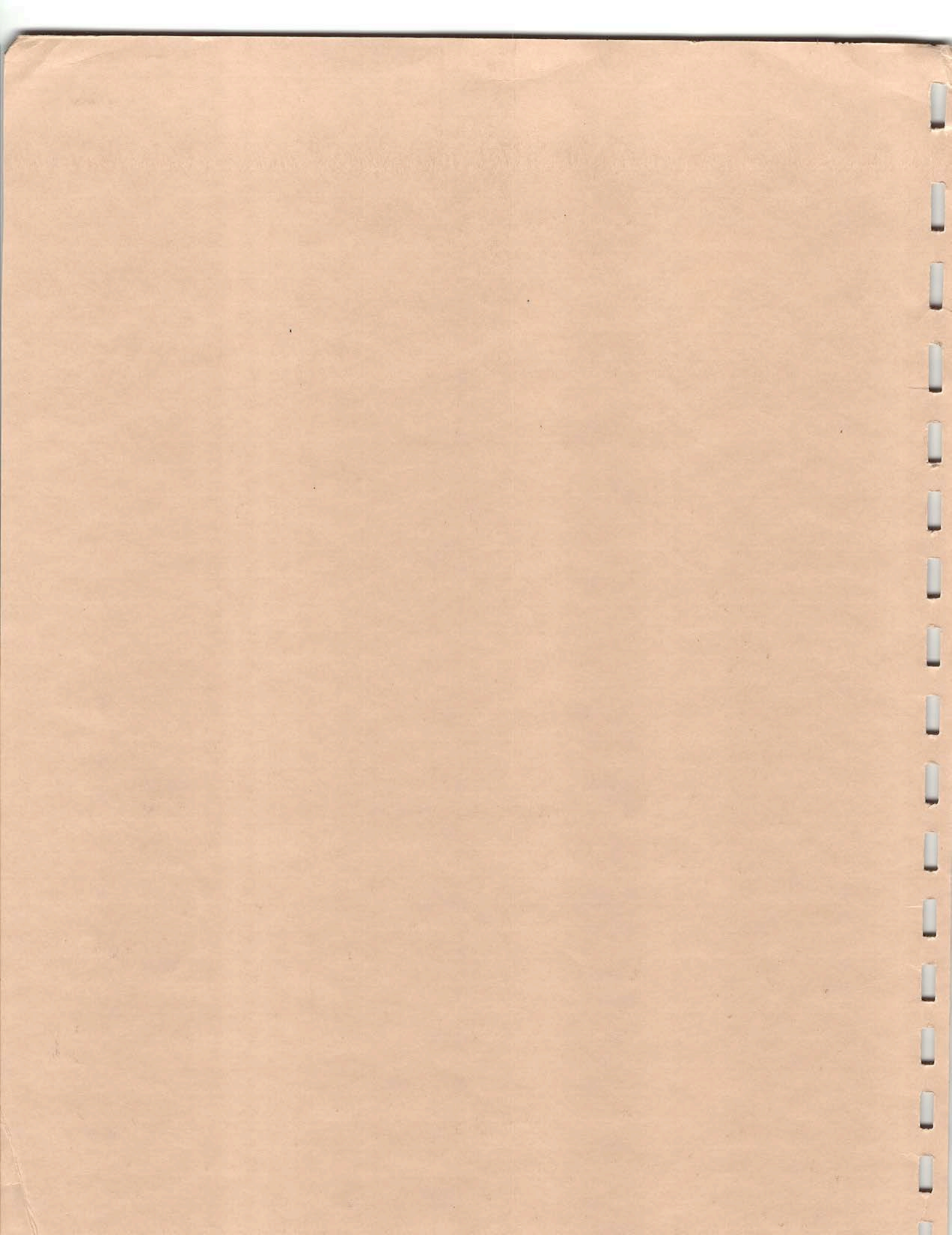

MENOMINEE
SOARING EAGLES

MEGAPHONE



Menominee

WINTER:
2756 Villa Ruhe
Marshfield, Wisconsin 54449
(715) 387-CAMP - Phone
(715) 384-8462 - Fax

SUMMER:
4985 Hwy. D
Eagle River, Wisconsin 54521
Phone - (715) 479-CAMP
Fax - (715) 479-5512

Glenn & Dawn Klein, Owners/Directors
(800) 236-CAMP

Fall 1994

Dear Camp Family,

You are about to read and enjoy one of the most outstanding megaphone Annuals in Menominee's 67 years. Lots of thanks and credit go out to Ari "Doc" Bernstein and all the writers, photographers, and layout folks who made this wonderful book of camp newspapers possible.

Megaphones are some of CM's greatest memorabilia, and the memories and awesome times that these pages will remind you of are truly priceless.

As the distance from the summer of '94 goes from months, to years, to decades - wherever you find yourself - always know, and find comfort in the fact, that you are loved.

Glenn + Dawn



Founded in 1928 by Nate & Edna Wasserman
Camp Menominee is an accredited member of the American Camping Association
Glenn & Dawn Klein are Certified Camp Directors





MEGAPHONE

FIRST "BALL" EDITION

JUNE 27, 1994



CM '94 Opens at Unveiling of New Al Lewis Field

ARI BERNSTEIN—

As the buses rolled into camp it was evident that the campers and counselors of Super Camp '94 were psyched for an awesome summer at the Friendly Confines. The inaugural ceremonies for the Summer of '94 were held in memorable fashion on the New Al Lewis Field. Campers were greeted by an ecstatic "tunnel" of CM counselors as GLENN read off the starting cabin lineups. Directly after the cabins were announced, the 1994 Menominee Scavenger Hunt commenced in full force as campers dashed around camp searching for three blades of grass from center field on new Al Lewis, two pebbles from Old Counselors Road, and "a word of advice".

Following the fast-paced Scavenger Hunt, the campers feasted upon the traditional first night meal of lasagna and deviled eggs. Later in the evening, campers signed up for their Big Ten Activities for the rest of summer.

While tradition showed itself grandly on the first day of Super Camp '94, campers began to discover many new and exciting things to come. For the first time in CM history, roller hockey on the new rink will be a Big Ten activity as well as a part of the in camp leagues known as the MCAAs (Menominee Camping Athletic Association). Campers will for the first time ever attempt to hit a bulls-eye on a home run to right on the new Al Lewis Field. Seniors cheered loudly when GLENN announced that every breakfast at CM this summer would be in "Lazy Day" format, where campers and counselors may eat at their leisure between 8:15 and 9:00 in the morning. A newly improved beach volleyball court was put in place down by the shores of beautiful Sand Lake, a brand new regulation soccer/football field stands level where the old Al Lewis once was, and the list goes on and on.

The first full day of CM '94 was speckled with liquid sunshine as we like to call it here at the Friendly Confines.

But this allowed campers and counselors to sign up and get ready to participate in the MCAAs. The five main leagues of the MCAA are: the MBA (Menominee Basketball Association), the MHL (Menominee Hockey League), MLB (Menominee League of Baseball), the MISL (Menominee Intense Soccer League), and the MFL (Menominee Football League). MCAA tournaments will be held in Tennis, Archery, Riflery, Swimming, Track, and Volleyball as well.

Super Camp '94 started off soaring and will undoubtedly be remembered as one of the greatest summers in CM history.

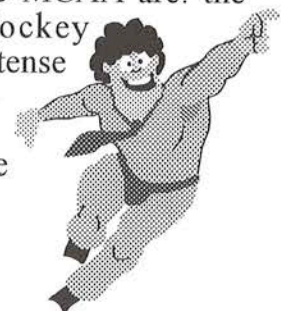
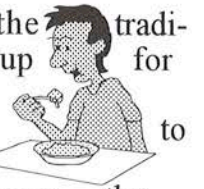



MEGAPHONE

EVENING FESTIVITIES EDITION

JUNE 28-30, 1994



COMMERCIALISM REIGNS AT CM

BRETT CHETEK—

As the 1994 Camp Menominee season began, so did the annual first night campfire, Commercial Night. There were many great skits, but only a few could come out on top. Cabins 10, 2, 4, and 5 were the lone winners in their divisions.

Cabin 4 (JEREMY EMER, JUSTIN HOROWITZ, ERIC ISRAEL, ROB KOHEN, JAMES MCGOVERN, MIKE REICH, JORDAN ROTHSTEIN, ERIC STANG, and JOSH ZEMEL) did an advertisement for Menominee Cola, which demonstrated the ability of the Cola to make average everyday kids into cool "Menominee" kids. Cabin 5 had a counselor auction led by MATT HOLLANDER, the auctioneer. ELLIOT LIEBERMAN was sold as JASON "EDDIE" WHITE, BRAD ROSS was in high demand as ROSS ALLEN, JASON HORN was sold as DROR NAFTALY, and

JAMEY STENDEL went as ANDY PINGER. The burgers of McMenominee were advertised by Cabin 10. DAVID SCHWARTZ explained the menu which included: the ROSS AUS Burger, "It's better than everything else," the BEAR Burger, "It's not just a burger, it's an animal," and the BEERMANN Burger, "Would you like regular or extra hair?" Cabin 2 advertised the New and Exciting Rag Cheer Tape which included such classics as, "1..2..3 Rag," and, "Gimme an 'R', gimme an 'A', gimme a 'G', what's that spell - RAG!"

One of the great things about these skits was the Menominee crowd. They were really into it and thoroughly enjoyed the evening's skits.

The crowd's response to the skits shows how good Commercial Night '94 was. One could even say they were in a league of their own.

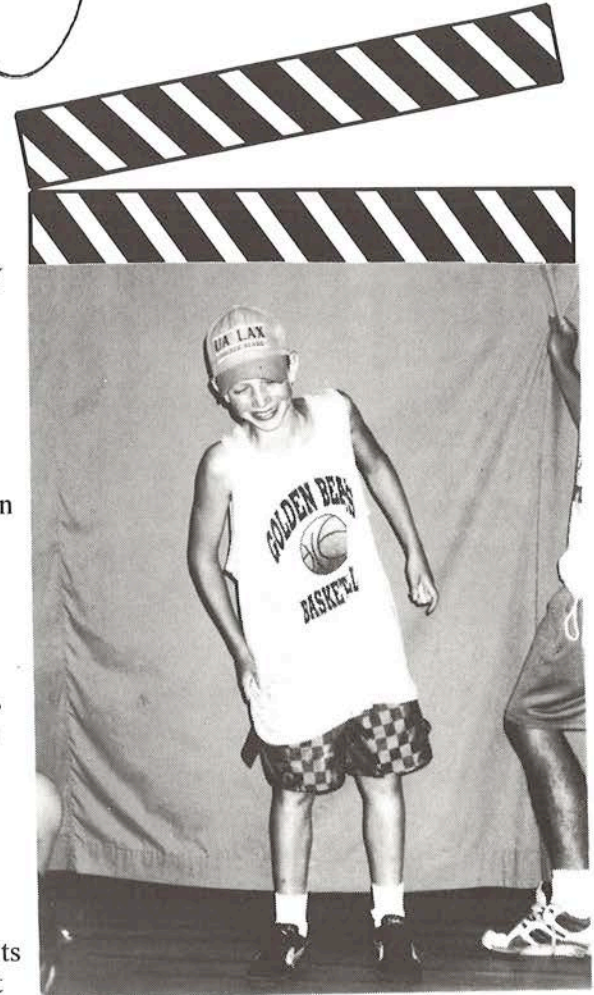

TOM NUTTER cracks himself up while telling one of his many jokes during a changeover in Commercial Night.

Operation Safe-Fun in Effect Again in 94

MAREK WALTON—

Chances are that if you are a counselor at Menominee, then you will have heard of, "Operation Safe-Fun," held at many different locations over the course of the summer. They include the Rhinelander Health Club, St. Germain community Center, and Chances "R", a bar in St. Germain, which will be non-alcoholic every Thursday night for the summer. The concept is for all the Northwoods camps to band together to help their staffs find fun and safe ways to spend their off-hours.

The first Thursday night of Super Camp '94



provided the first opportunity to attend Operation Safe-Fun at Chances "R". The ride over was filled with anticipation for this reporter, as I hadn't met many other counselors from other summer camps in the Northwoods including Camp Marimeta, Deerhorn, Ojibwa, and many others. Outdoor volleyball, pool, and loud music as well as an alcohol and drug free environment were provided by Chances "R".

All in all, I believe Chances "R" will be a place worth checking out if you want to meet your opposite numbers and learn how to improve your volleyball!

EGG DROP SOUPERIOR



(1) Cabin 6 lets go of their masterpiece.

(2) BOMBS AWAY! As LARRY MILLER, JOHNNY SCHATZ, MATT COHEN, and TODD SCHWARTZ watch Cabin 12's cradle fall.

(3) ZLOTY displays the eggs of winners.

ANDY ZLOTNIK—

As another season at Camp blossoms, it was once again time for the informal convocation of summer; the Fourth Annual Egg Drop Contest. ZLOTY DIVATZ headed up what has been regarded by some observers of camping rituals as the pinnacle of all summer camp events. The rules of the game are simple. But the task, as seen by the results, was a much heavier chore.

Each cabin was given 45 minutes to make a basket to cradle their egg and keep it from breaking when it crashed to the ground after being dropped some 400 inches off the top of Wass Hall. The trick though was to make the basket with only natural substances.

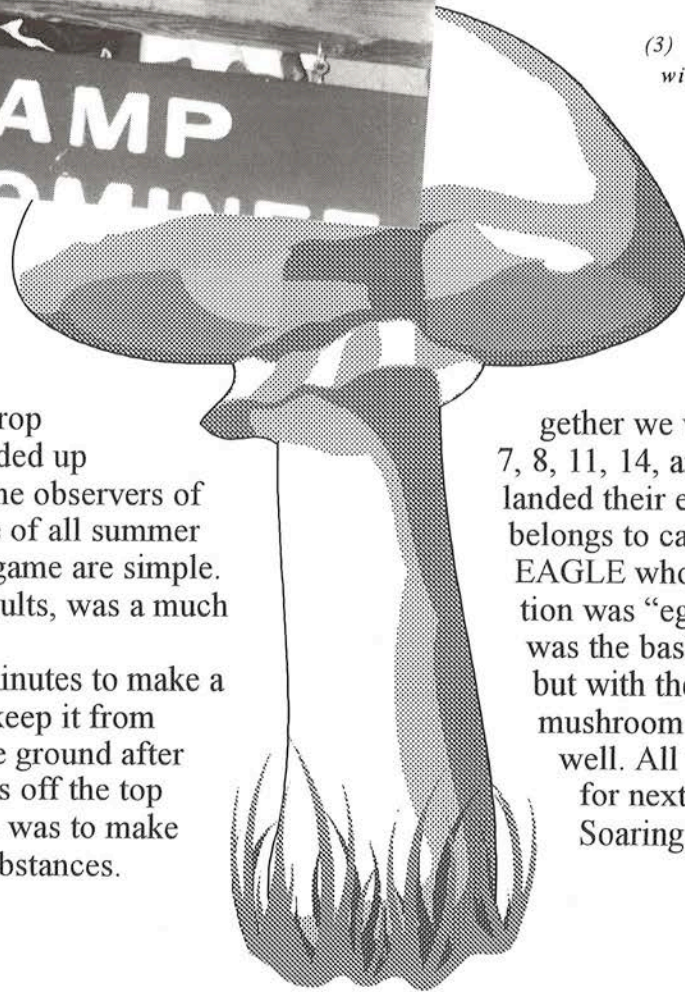

Helping me to judge the contest was my right-hand-man and scorekeeper SETH RHEINGRUBER. Together

we watched as cabins 3, 5, 6, 7, 8, 11, 14, and 17 each successfully landed their eggs. But the day really belongs to cabin 13 and AARON EAGLE whose egg cradling contraption was "eggceptional." Not only was the basket masterfully crafted but with the addition of a giant mushroom it was beautiful to see as well. All we can do now is wait for next year for Menominee's Soaring Eggs.

MEGAPHONE

TWI-LIGHT LEAGUE EDITION

JULY 1, 1994

Seniors Start Season Seeing Silver Trophy In Future



JON KULESZA—

The starting of Senior Twi-Light League was phenomenal. Despite playing only six men in the field (plus counselor supplements), all four teams played incredible defense. REID BARTHA and RICKY KIRSCH pitched great games for their respective teams: Reid's Rampaging Water Lilies and Kirschy Squirts. BARTHA's "moon ball" pitch was tough, but unfortunately for his team they came up on the short end.

In the other game out on the scenic Bob Bender Senior Diamond, Goodman's Gefilte Fried Kosher Canned Hams knocked off Polsky's Pulsating Pickled Pig Plop in a well played, hard hitting match-up.

One can see an exciting summer ahead for Senior Twi-Light League. The scores have been close and the teamwork excellent! Who will take home The Trophy? Go get it guys!

Intermediate Twi-Light League Starts Off With a Bang

CORY PROVUS—

As the summer of '94 begins, it seemed that Twi-Light League had started a long time ago, especially for the Intermediates. While the teams and the captains were announced, the intensity level was high. In the past, a key to a success-

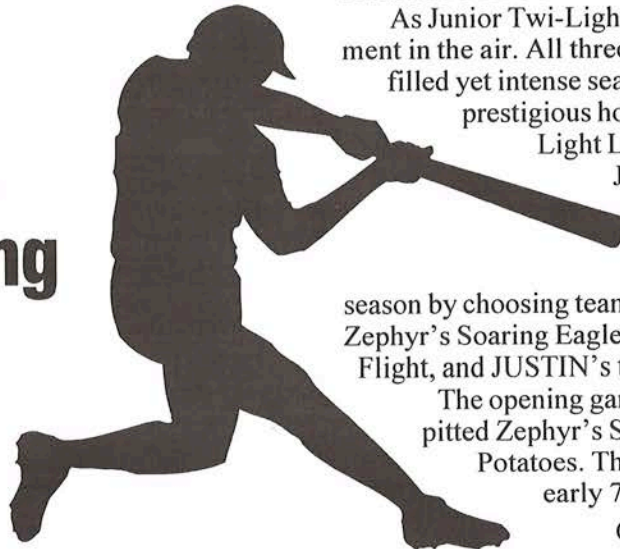

ful team was a good captain. This year the captains who wish to lead their teams to victory are: JORDAN GRANT, ELLIOT LIEBERMAN, JOEL SORINSKY, JORDAN GAULE, JARRET TURBIN, SCOTT SCHAFF, ETHAN HOROWITZ, and JAY GUSTAFSON.

The opening games of Intermediate Twi-Light League saw the teams psyched to win. Playing on Diamond #4 were Grant's Giant Gazungas and Ethan's Enormous Ear Eating Eels. On the all new Diamond #6, a fine pitching performance was turned in by SCOOTER GOLDNER of Gaule's Gill-gutted Gefilte Fish which led Gaule's team to a 12-0 victory over Turbin's Tornadoes. On Diamond #7, captain JAY GUSTAFSON put on a hitting clinic along with teammates CHRIS CADY and BRETT CHETEK to jolt their team to a 6-4 victory over Lieberman's Lethal Lasagna Lumps. Finally, in a recap of the day's action, on Diamond #8 captain JOEL SORINSKY led his team, Sorinsky's Studly Sundials, to victory over Schaff's Salivating Superstars 9-2.

For commissioners ARI BERNSTEIN, GREG ABRAMS, and CORY PROVUS, this awesome start to the season points to one of the most intense and possibly the closest Intermediate Twi-Light Leagues ever.

Juniors Commence TLL Campaign

FRANK JOHNSON—

As Junior Twi-Light League begins there is excitement in the air. All three teams are prepared for a fun-filled yet intense season in hopes of capturing the prestigious honor of being named Junior Twi-Light League Champions. Captains

JOSH ZEMEL, JORDAN ROTHSTEIN, and JUSTIN HOROWITZ got their teams motivated for the upcoming

season by choosing team names. ZEMEL's team is called Zephyr's Soaring Eagles, ROTHSTEIN's is Jordan's Nike Flight, and JUSTIN's team name is Spuds Potatoes.

The opening game of Junior Twi-Light League pitted Zephyr's Soaring Eagles against Spuds Potatoes. The Soaring Eagles jumped out to an early 7 to 2 lead with help from hitters

CONTINUED ON NEXT PAGE...

ERIC ISRAEL and JOSH ZEMEL. Defensive help came from JAMIE McGOVERN. However, led by JUSTIN HOROWITZ, ANDREW DRAFT, and MIKE REICH the Potatoes came frying back to take a 15 to 7 lead going into the last inning. The Eagles comeback led by JUDAH KLEIN's two run single, fell short. The final score was 15 to 11.



Twilight League "Advances"

ROSS AUSLANDER—

Yeah, Rah! Rah! It's the start of the new, never been done before, Advanced Twilight League. Yes, ladies and gentlemen, the 13 year old age group is now in Advanced Twilight League. ATLL is a division between Intermediate and Senior Twilight Leagues. The first ever captains for this prestigious League are: LARRY MILLER, TED ROTH, PHILIPPE IFERGAN, and ALEX YUSPEH. ATLL is played with a 12 inch softball. The main field for ATLL is the New Al Lewis Field. There is always the potential for hitting one over the fence. Being an umpire for the first game ever in ATLL was quite an experience. Myself and brother Stewart are the commissioners of the league and are foreseeing a successful season ahead.

1994 Sr. TLL Rosters

Goodman's Gefilte Fried Kosher Canned Hams

BOBBY GOODMAN, Capt.
BRIAN ANDALMAN
TODD BLOCK
REED EDWARDS
JEREMY FRYDMAN
AARON PERNA
EVAN ROSENBERG
GM: JASON WHITE

Kirschy Squirts

RICKY KIRSCH, Capt.
STEVEN KATZ
ENRIQUE OJEDA
MATT PASSEN
ADAM SCHREIER
PHILIP STERNHELL
GM: BARRY QUAYLE

Reids Rampaging Water Lillies

REID BARTHA, Capt.
JEFF DAVIDSON
JOE JACKSON
JON JAPHA
DAVID LEZAK
ELLIOT PESSIS
BRANDON SMITH
GM: MIKE BURLING

Polsky's Pulsating Pickled Pig Plop

GABE POLSKY, Capt.
DAVID CHERNER
AARON EAGLE
JAKE GOLDNER
JEFF HOOD
MICHAEL MASON
ANDY SCHIMEL
JOSE VILLAVICENCIO
MATTHEW WEISS
GM: ANDY ZLOTNIK

1994 Advanced TLL Rosters

Alex's All American All Stars

ALEX YUSPEH, Capt.
TREVOR ABRAMSON
BRAD BROOK
DAVID DAVIDSON
JEFF DRITZ
ROSS EDWARDS
ANDERS JOHNSON
JOHNNY SCHATZ
TODD SCHWARTZ
BRYAN SIMKIN
BRIAN TEPPS
GM: ANDREW PINGER

Millhouse Martyrs

LARRY MILLER, Capt.
BRIAN ANDROW
JOSE BASAGOITI
TOM BUDASZ
MATT COHEN
MATT FRANK
MATTHEW GROSS
EVAN HERMAN
HARLEY ROSENTHAL
BARRY SCHWARTZ
ZACK WEINER
GM: GAVIN SPOWAGE

Philip's Flying Flapjacks

PHILIP IFERGAN, Capt.
RONJON DATTA
JAMES DICKEY
STUART EMMERMAN
JORDAN GOLDFARB
JOHN PATRICK JACOBS
JUSTIN JACOBSON
DANNY LEVY
CRAIG RASHKOW
TODD RHEINGRUBER
JOE ROSENBAUM
GM: JASON BELCHER

Teddy's Terrorizing Torpedoes

TED ROTH, Capt.
ANDREW BENDER
LEONARD FIALHO
SCOTT KAPLAN
ENRIQUE LONA
HERBIE LUKES
JOSH MERSFELDER
BRAD MOSS
SETH RHEINGRUBER
MATT ROTHSTEIN
ROSS SIDER
COLIN TAHI
GM: ROB EMERY

Ethan's Enormous Ear Eating Eels

ETHAN HOROWITZ, Capt.
JAVIER BASAGOITI
PETER BERNICK
GEORGE BURDEN
MATT FINDER
MICHAEL HERTZ
KEI KATO
MATT KAUFMAN
JUSTIN MATIMORE
PABLO MAYO
GM: ERIK ECKBLAD

Turbin's Tornadoes

JARRET TURBIN, Capt.
MATT BERCOVITZ
JEREMY GLAZMAN
STEPHEN GOLER
ADAM GREENBERG
MICHAEL HIRSCH
ADAM KAPLAN
JOSH KURZMAN
MIKE MESIROW
BRETT PESSIS
GM: ARI ROSEN

Jay's Lays Potato Chips

JAY GUSTAFSON, Capt.
CHRISTOPHER CADY
BRETT CHETEK
DREW EDWARDS
OREN JACOBSON
JEREMY MATIMORE
ANDY SLUSSER
JEFFREY STEIN
BRIAN SUMERS
COLIN WEINER
GM: CORY PROVUS

Grant's Giant Gonzangas

JORDAN GRANT, Capt.
ANDRES ARAIZA
SIM DARWICK
JEFF J. DAVIDSON
CHRIS DICKEY
RENE HERTSBERG
JAKE NEIMAN
ADAM WEINGARTEN
MARTY WEISMAN
GM: TONE TURNER

1994 Intermediate TLL Rosters

Sorinsky's Studly Sundials

JOEL SORINSKY, Capt.
JOSHUA BENJAMIN
EVAN HARRIS
JASON HORN
MATTHEW KLEIN
BRAD MENDEL
BRETT RHEINGRUBER
JAMEY STENGEL
SAM YUSPEH
BRIAN ZAANDER

Gaule's Gill-Gutted Gefilte Fish

JORDAN GAULE, Capt.
PETER EHRLICH
JONATHAN FELDMAN
BRETT GOLDNER
MATTHEW HOLLANDER
RYAN HOLZ
DAVID SCHWARTZ
JON SIEGEL
STEPHEN STEIN
JONATHAN WALTON
GM: ALAN TRUBOW

Schaff's Salivating Superstars

SCOTT SCHAFF, Capt.
JASON KUMMER
KEANAN LEVANT
DOUG LEVIN
BRANDON LEVY
JAKE MEILACH
ELI PLATT
JARED RALSKY
DANIEL ROSEN
NICHOLAS TALBOT
GM: BRIAN WHITFORD

Lieberman's Lethal Lasagna Lumps

ELLIOT LIEBERMAN, Capt.
MATTHEW GOODSTEIN
JEFFREY HERTZ
CASEY HINTZ
DAVID KRAUT
TOMMY NUTTER
BRADLEY ROSS
MICHAEL WEINER
BRIAN WHITE
GM: JASON SCHWARTZ

1994 Jr. TLL Rosters

Zephyr's Soaring Eagles

JOSH ZEMEL, Capt.
BRANDON DAVIS
JEREMY EMER
ERIC ISRAEL
JUDAH KLEIN
JAMES McGOVERN
ALEX STEIN
GM: NICK OLSON

Spud's Potatoes

JUSTIN HOROWITZ, Capt.
ANDREW DRAFT
JOSEPH KLEIN
ROB KOHEN
JARED OLIAN
MICHAEL REICH
MATTHEW SCHWARTZ
GM: JOSH ROTHENBERG

Jordan's Nike Flights

JORDAN ROTHSTEIN, Capt.
JOSHUA HELLER
HARRIS KEALEY
JACOB KLEIN
JESSE LATORRE
J.D. McCORMICK
ERIC STANG
GM: JOPLIN SELL

MEGAPHONE

SAILING AWAY EDITION

JULY 2-3, 1994



C.M. Sailors Take Second At Kawaga

NICK OLSON—

From the lead boat, one could see a laser out ahead of the pack for the majority of the Kawaga Regatta. While Menominee's team of TODD BLOCK and CASEY HINTZ finished second, the speed of their sunfish proved to be no match for the far

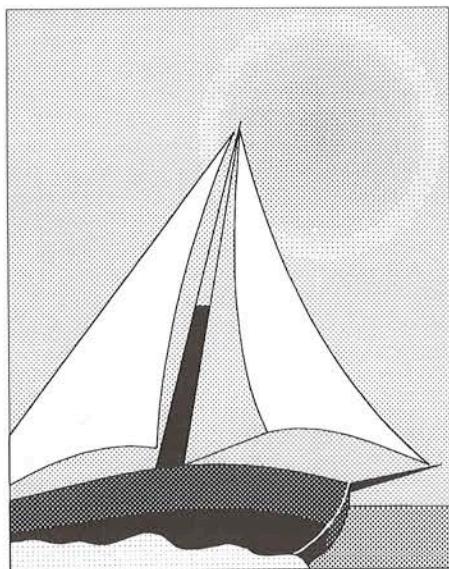

faster laser from Red Arrow Camp. PHIL STERNHELL and EVAN ROSENBERG were sailing along with BLOCK and HINTZ at the start, but apparently forgot to raise their daggerboard over a two foot deep sand bar, and stopped abruptly. They caught up eventually, and sailed in third place until about ten yards from the finish. There, they were passed by a Nicolet boat. JASON HORN and JOSH BENJAMIN sailed well in the main pack of boats and ended up tying for twelfth, a rare occurrence in the sport of dinghy racing. JAMES McGOVERN and BRANDON LEVY sailed the Menominee way by finishing last rather than quitting despite the light wind conditions. It was a good day for sailing and for Menominee. We came in second as a team by only

one point to Camp Nicolet. The next Regatta is Chippewa's, which all of us are looking forward to.



12 And Under Hardball Proves That End Score Doesn't Always Deter- mine A Winner

ROB EMERY—

On Friday night St. Germain was at C.M. for the first Super Camp game ever on the new Al Lewis field. The St. Germain Sox were beginning their playoff run and showed that they had practiced much before this game. The Menominee Twins of the Central Division in the MLB began the game with great enthusiasm and played superbly as well despite having only one practice. The Menominee Royals also played during this first game on new Al Lewis. ADAM KAPLAN played particularly well and superb pitching performances were turned in by veterans: CHRIS CADY, BRETT CHETEK, SCOTT SCHAFF, and JOEL SORINSKY. The teams that played would like to thank Menominee for the awesome crowd present at the game that cheered our guys on. Unfortunately, the final score did not reflect the level of play by the Menominee teams in their loss to the World Series bound St. Germain Sox.

IMITATION:

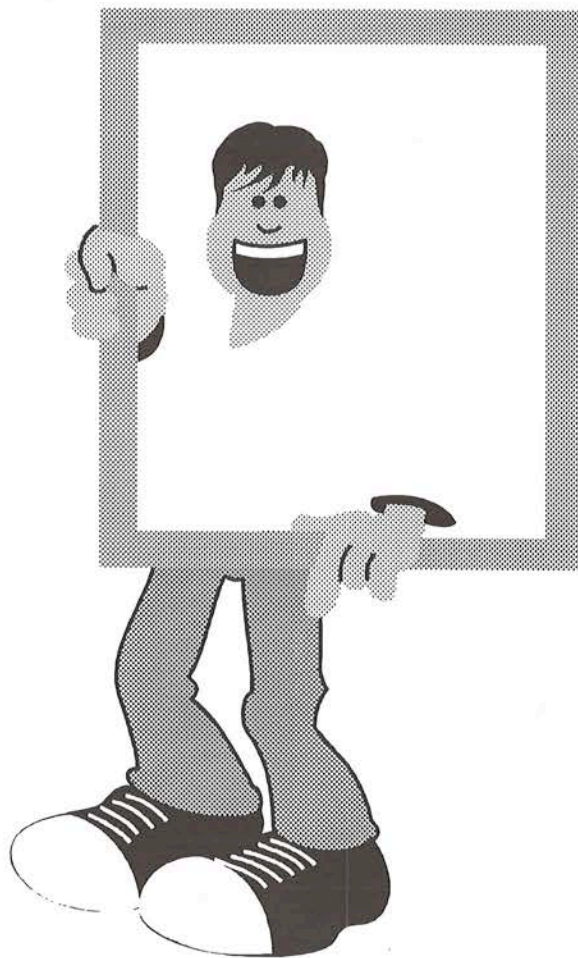

THE HIGHEST FORM OF FLATTERY

MIKE HERTZ—

Imitation Night '94 was packed full of excellent, fair, and some "gong worthy" imitations of Menominee staff, among other things. Frequent targets of imitation were ROSS AUSLANDER and his high self-concept, FRANK JOHNSON's personal allure, BRETT GOLDMAN's rifflery range strictness, BRYAN WHITFORD's hand gesturing, and BEAR's ability and thirst for hibernation. Imitation Night climaxed with Cabin 14's phenomenal imitation of GLENN teaching the camp cheers. Two teams were pitted against each other to see who could lead the best cheer. Here is how JAKE MEILACH attempted to do so: "It-szoo, Rot-szoo, teddy, boom, bot-szoo ... NO! Slowly now. Teddy, boom, bot-szoo ..."

Judges on night one were DEAN "the Australian Dream" ANDREW, the brilliant TONE TURNER, and the stunningly handsome BARRY QUAYLE. Night two featured STU "Nate" AUSLANDER, JASON "Haka-boy" BELCHER, and the ever so charming MAV WALTON as judges.

The MC's were ANDREW PINGER on night one, and Sleepy Pink Floyd LLOYD ECKBLAD on the second night. LLOYD awarded Cabins 4 and 13 first places on the second night and ANDREW awarded Cabins 8 and 14 on night one. All first place participants enjoyed a free canteen for their efforts in entertaining Menominee once again.



MEGAPHONE

RED-COATS RULE EDITION

JULY 4, 1994



British Reverse History

JEREMY FRYDMAN—

British and American traditionally takes place on America's Birthday, the Fourth of July. Last year and in 1776, the Americans were the victors. This year, however, would prove to be different. After two disappointing losses in cheering and the Captain's Duels, the British came back to win the Land and Sea events. The Americans, however, set the British back once more with another loss in the All Camp Squirt Gun Fight. The following campers survived the half hour grueling battle:

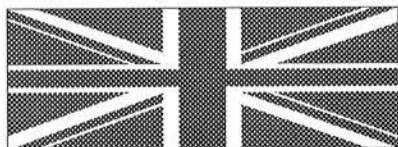

British Survivors

MICHAEL WEINER (25 Pointer)

PETER EHRLICH

LARRY MILLER

STUART EMMERMAN

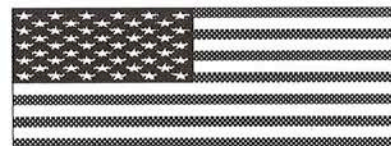

American Survivors

TODD BLOCK

JEREMY EMER

TREVOR ABRAMSON

BRIAN ANDALMAN (25 Pointer)

TED ROTH

DAVID CHERNER

ALEX YUSPEH

DANIEL ROSEN

JUSTIN HOROWITZ

ELLIOT PESSIS

BRANDON DAVIS

NICK TALBOT

So, it came down to the final event of B&A '94, Message to Garcia. The end results were close. Both the British and the American's

JASON HORN focuses for his Captain's Duel surrounded by his fellow countrymen.



PHILIPPE IFERGAN concentrates on the potato in the potato on the spoon relay.



MATT GROSS and ALEX YUSPEH lunge for the rope during potato on the spoon.



got their 25 pointers across OCR. They were SCOTT KAPLAN for the Americans and JUDAH KLEIN for the British. Here are the other campers who got their message to Garcia:

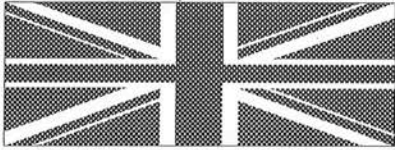

British Messengers

MICHAEL WEINER
SIM DARWICK
JEREMY MATIMORE
OREN JACOBSON
GABE POLSKY
ERIC STANG
NICK HOUCHENS
ELLIOT LIEBERMAN
BARRY SCHWARTZ
PETER EHRlich
JUDAH KLEIN
EVAN ROSENBERG
MATT GROSS

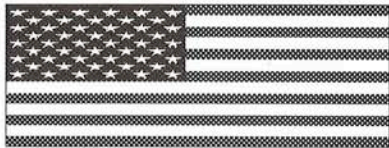

American Messengers

BRETT RHEINGRUBER
SETH RHEINGRUBER
JEREMY GLAZMAN
JORDAN GAULE
ETHAN HOROWITZ
MICHAEL REICH
DAVID CHERNER
MATT FRANK
JUSTIN HOROWITZ
PHILIPPE IFERGAN
BRIAN ANDROW
SCOTT KAPLAN
RICKY KIRSCH

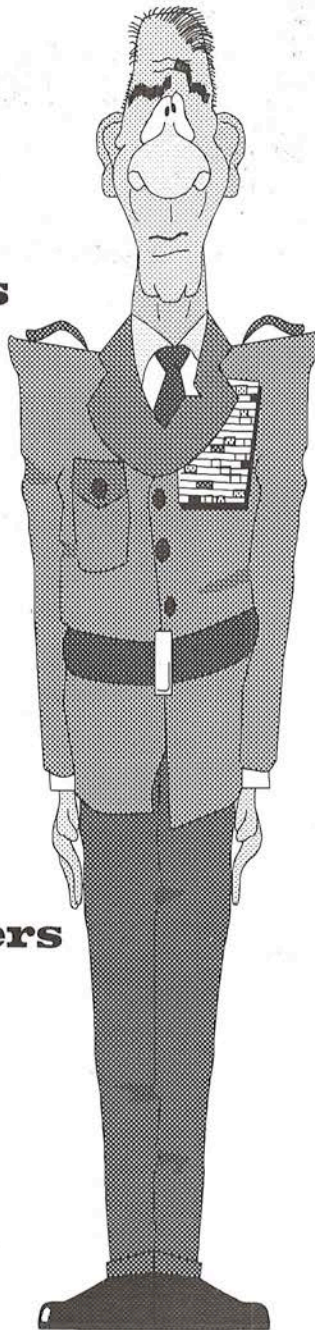

After all the tallies had been made, penalty points assessed, bumps and bruises cared for, the final score was 48 to 46 in favor of the British. The British had won B&A.

Quite possibly this year's B&A was the best in a long time. Undoubtedly, the Senior Cabin had profound effect upon the end results. Captained by JEREMY FRYDMAN, the British Senior Cabin members included: MATT PASSEN, GABE POLSKY, REID BARTHA, EVAN ROSENBERG, and PHILLIP STERNHELL. The Americans were led by AARON EAGLE and the only Senior Cabin member on the American team was BOBBY GOODMAN.

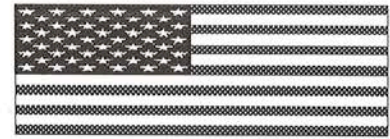

1994 Americans

TREVOR ABRAMSON
BRIAN ANDALMAN
BRIAN ANDROW
MATT BERCOVITZ
TODD BLOCK
GEORGE BURDEN
DAVID CHERNER
BRANDON DAVIS
JEREMY EMER
LEONARD FIALHO
MATT FRANK
JORDAN GAULE
JORDAN GOLDFARB
BRETT GOLDNER
JAKE GOLDNER
STEPHEN GOLER
BOBBY GOODMAN
MATTHEW GOODSTEIN

ANDREW BENDER, JOHNNY SCHATZ, STUART EMMERMAN, BARRY SCHWARTZ, and LARRY MILLER scramble for a lost spud.



It's a race to fill the canoe between the Senior teams of British and American.

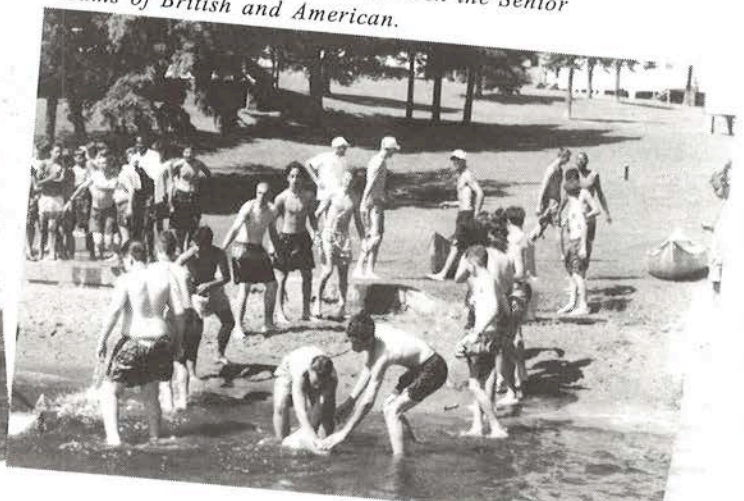

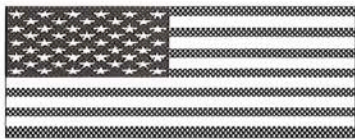

Americans Continued

JORDAN GRANT
 RENE HERTSBERG
 JEFFREY HERTZ
 CASEY HINTZ
 MICHAEL HIRSCH
 RYAN HOLZ
 ETHAN HOROWITZ
 JUSTIN HOROWITZ
 PHILIPPE IFERGAN
 JOE JACKSON
 JUSTIN JACOBSON
 JON JAPHA
 ANDERS JOHNSON
 SCOTT KAPLAN
 KEI KATO
 RICKY KIRSCH
 JOSEPH KLEIN
 MATTHEW KLEIN

DAVID KRAUT
 JASON KUMMER
 JESSE LATORRE
 KEANAN LEVANT
 DOUG LEVIN
 DANNY LEVY
 JAMES McGOVERN
 JAKE MEILACH
 BRAD MENDEL
 MIKE MESIROW
 JARED OLIAN
 ELLIOT PESSIS
 ELI PLATT
 CRAIG RASHKOW
 MICHAEL REICH
 BRETT RHEINGRUBER
 SETH RHEINGRUBER

DANIEL ROSEN
 JOE ROSENBAUM
 TED ROTH
 MATT ROTHSTEIN
 SCOTT SCHAFF
 ADAM SCHREIER
 DAVID SCHWARTZ
 MATTHEW SCHWARTZ
 BRYAN SIMKIN
 ALEX STEIN
 JAMEY STENGEL
 BRIAN SUMERS
 NICHOLAS TALBOT
 ADAM WEINGARTEN
 MARTY WEISMAN
 ALEX YUSPEH
 BRIAN ZAANDER

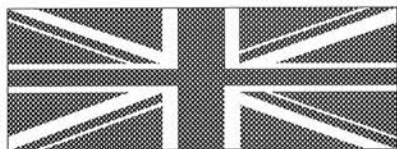

1994 British

ANDRES ARAIZA
 REID BARTHA
 JAVIER BASAGOITI
 JOSE BASAGOITI
 ANDREW BENDER
 JOSHUA BENJAMIN
 PETER BERNICK
 BRAD BROOK
 CHRISTOPHER CADY
 BRETT CHETEK
 MATT COHEN
 SIM DARWICK
 DAVID DAVIDSON
 JEFF J. DAVIDSON
 ANDREW DRAFT
 JEFF DRITZ
 DREW EDWARDS
 ROSS EDWARDS
 PETER EHRLICH
 STUART EMMERMAN
 JONATHAN FELDMAN
 ADAM GREENBERG
 JAY GUSTAFSON
 EVAN HARRIS
 JOSHUA HELLER
 EVAN HERMAN

MICHAEL HERTZ
 NICK HOUCHENS
 ERIC ISRAEL
 OREN JACOBSON
 ADAM KAPLAN
 HARRIS KEALEY
 JACOB KLEIN
 JUDAH KLEIN
 BRANDON LEVY
 ELLIOT LEIBERMAN
 HERBIE LUKES
 MICHAEL MASON
 JEREMY MATIMORE
 JUSTIN MATIMORE
 PABLO MAYO
 J.D. McCORMICK
 JOSH MERSFELDER
 LARRY MILLER
 BRAD MOSS
 JAKE NEIMAN
 TOMMY NUTTER
 MATT PASSEN
 AARON PERNA
 GABE POLSKY
 JARED RALSKY
 TODD RHEINGRUBER

EVAN ROSENBERG
 BRADLEY ROSS
 JORDAN ROTHSTEIN
 JOHNNY SCHATZ
 BARRY SCHWARTZ
 TODD SCHWARTZ
 JON SIEGEL
 BRANDON SMITH
 JOEL SORINSKY
 JEFFREY STEIN
 STEPHEN STEIN
 PHILIP STERNHELL
 BRIAN TEPPE
 JARRET TURBIN
 MICHAEL WEINER
 MATTHEW WEISS
 SAM YUSPEH
 JOSH ZEMEL

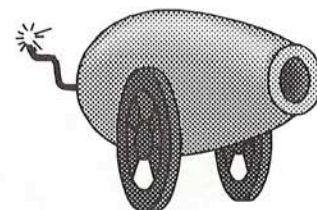



MEGAPHONE

P.M. FUN EDITION

JULY 5-6, 1994



Many A Memorable Moment At Meta Social

BRYAN SIMKIN—

On July 4th, 1994, we and the girls from Marimeta had an evening social. The boys from Menominee in cabins 1, 2, 11, 12, 13, 14, 15, 16, and 17 stayed at home while the rest of the camp went over to our once sister camp. The Mess Hall was converted into a disco scene, highlighted by KOZ'S light set-up, for the Seniors. Wass Hall was occupied by the Intermediates. During

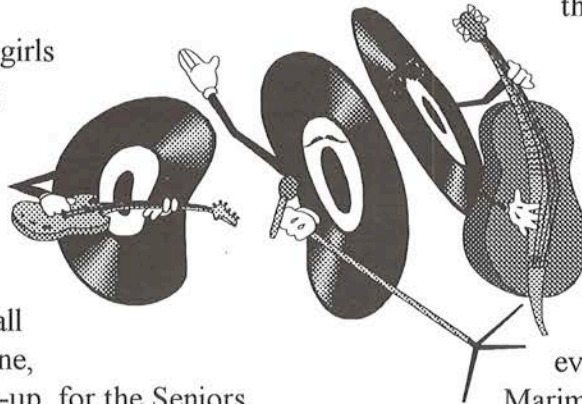

the social, campers enjoyed, food, drinks, music, dancing and of course the socializing. High compliments were given to the pizza and lemonade, as well as the DJ's which included ANDREW PINGER and KOZ.

Overall, just about everyone who attended the social had a blast. The evening was definitely a great social with Marimeta.

C.M. Hardball Downs E.R. By A "Fieldgoal"

FRANK JOHNSON—

Since it was raining most of the day, the hardball game against Eagle River was moved to a field near the second hold of the golf course since Al Lewis Field was under H2O. This provided a dry spot for the Menominee to take their win. We had 18 players, so everyone was able to hit twice. ERIC ISRAEL was an intimidating force on the mound for the first three innings. JEREMY EMER, JOSH ZEMEL, JUSTIN HOROWITZ and ISRAEL each had 2 hits and led the offensive attack that scored 13 runs. ANDREW DRAFT pitched the final two innings and the Menominee Defense held off a last inning comeback by Eagle River All Stars to win 13 to 10.



CAMPERS DO THE MONSTER MASH



< LEONARD FIALHO and ALEX YUSPEH assault SETH RHEINGRUBER in Cabin 11's Monster Night Skit.

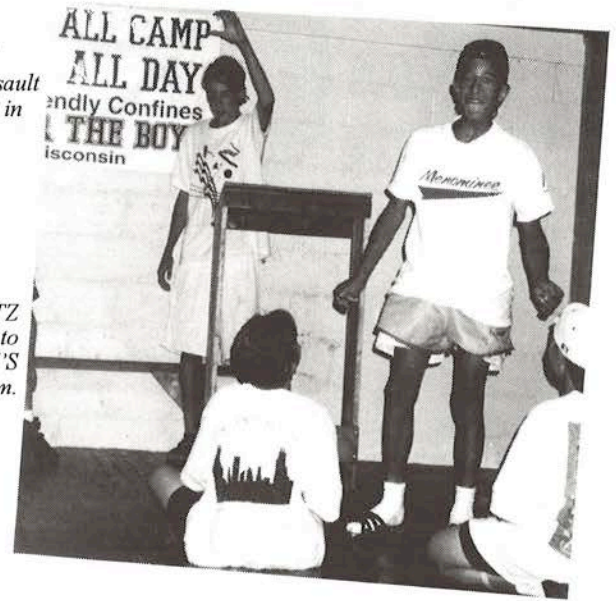

> JOHNNY SCHATZ responds to COLIN TAHI'S words of wisdom.

ALAN TRUBOW—

“Twas the night before OJ, but before campers snored, it was time for Monster Night 1994. Yes, for the first time in recent C.M. history it was Monster Night. All cabins had to make up three minute skits that included a monster. They were judged by their creativity, comedy, and cabin involvement. So, we gathered into Wass Hall and the tone was set quickly by Cabin 3 who took the stage and enthralled the rest of the Junior Division. HARRIS KEALEY played Mr. Buckethead in the winning skit.

Cabin 9 took the Intermediate Division with MARK CHAPIN acting as the crazed “Musky Murph” who allegedly killed two individuals with his fishing rod while trying to reel one in. MATT FINDER and DAVID KRAUT duked it out as attorneys while JASON KUMMER presided over the trial.

Then came the Seniors. With a controversial victory COLIN TAHI led his cabin in the “Church-house Massacre.” TAHI saved the soul of MATT ROTHSTEIN by the use of his healing power. However, LARRY MILLER decided it was not to be and killed everyone present. All in all, a great time was had and there were many laughs distributed by the winning cabins. For their efforts in Monster Night, the winning cabins received free canteens.

Day Campers Called Up To The Big Leagues

JOPLIN SELL—

The Tamarak Day Campers arrived at the Friendly Confines of Camp Menominee full of energy, spirit, and enthusiasm! They were given a quick tour of Camp and then had an awesome time, with ROSS ALLEN, swimming their twelve laps so that they could utilize the waterfront facilities to their fullest during their stay. As the new and official Cabin 19, they were allowed special early meals and first dibs on canteen every night. The guys also put on a great skit during Monster Night as they demonstrated how a monster prepares himself for a typical camp day. Some of the things the Tamarak Campers said they will remember the most from their visit to C.M. were: tubing, water skiing, archery, roller hockey, and playing hardball on New Al Lewis Field. The guys were great and we hope to see them as C.M. campers next year.

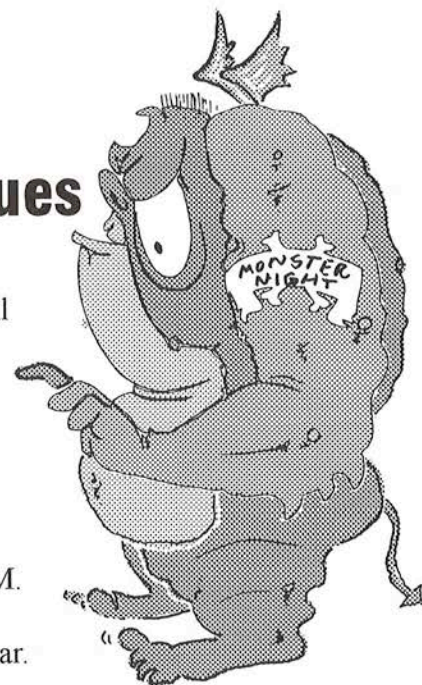



MEGAPHONE

BIG DAY VS. OJ EDITION

JULY 7, 1994



16A Defines Meaning Of MEN

MARC BEERMANN—

On July 7, 1994 the 16A softball team looked to avenge last years loss against Ojibwa. In the first inning, Ojibwa took a 1 to 0 lead, but Menominee showed why our first three letters are MEN, stepping up in the second half of the first inning to score 3 runs led by STEW AUSLANDER and GREG ABRAMS. Driving them in with a sweet home-run was ROSS AUSLANDER. In the second inning, we went 1-2-3 on defense and on offense. In the third inning, we met our match when Ojibwa scored

4 runs to take a 5 to 3 lead. Later in the 4th inning, they scored another run while we were left scoreless. Finally, in the fifth inning, the men of Menominee pulled it together to surprise Ojibwa. ALAN TRUBOW, BOBBY GOODMAN, ARI ROSEN, PHILIP STERNHELL, and MATT PASSEN all made it around the bases to produce a five run inning. Even though Ojibwa scored in the next inning, we were able to keep them scoreless in the final inning. Thanks to great defense and tremendous hitting, the 16A was able to defeat Ojibwa 8 to 7. Great job guys!

C.M. Eagles Soar In 16B Thriller

MIKE BURLING—

Although it was a dark, gloomy day on New Al Lewis, it did not dampen the Soaring Eagles spirit or intensity. Led by the pinpoint control of pitcher JEFF DAVIDSON, the defense responded with a phenomenal game. The left side consisting of shortstop RICKY KIRSCH, third baseman REID BARTHA, and left fielder CORY PROVUS, proved to be a collective vacuum as many potential OJ hits were turned into outs by these fielders. Even though the game was low scoring, Menominee continually strung together hits and threatened to score in every inning. They finally broke through in the bottom of the second. With one out, KIRSCH lined a single to left and went to third on a throwing error. Then, with two out, JOSH "YOSH" ROTHENBERG delivered a single to score KIRSCH and even the score at one. After JASON "DA BEAR" SCHWARTZ, AARON EAGLE, and BRANDON SMITH all singled in the fourth the bases were loaded with nobody out. Unfortunately, Menominee failed to score. However, instead of getting down, the Eagles picked up the intensity, especially on defense. In the sixth, already down 3-1, perhaps the play of the game was made. With two out and two on Menominee had a throwing error, that sure looked like another potential Ojibwa run. However, the outstanding hustle of SCHWARTZ, SMITH, and ELLIOT PESSIS prevented

the ball from going out of play and letting the run score. JEFF DAVIDSON then got the last out. In the bottom of the inning CORY PROVUS led off with a double and advanced to third on ADAM SCHREIER's sacrifice. He then scored on a sacrifice fly by SCHWARTZ to close the gap to 3-2. The stage was set and the drama mounted in the seventh.

The defense got though and retired Ojibwa one, two, three. In the bottom of the inning, EVAN ROSENBERG delivered a single and went to second on an error. PROVUS then advanced him to third and with two out it was up to DAVIDSON. After watching two balls, he drilled the next pitch to the gap in right-center that got by the Ojibwa fielders. ROSENBERG easily scored and DAVIDSON rounded the bases just beating the throw home and safely slid in with the winning run!! The team went crazy knowing they had given everything they had to a win that was undoubtedly a TOTAL team effort.





Full Stomachs Leave Empty Feeling But

No Regrets

"H"—

Thursday, Menominee traveled to the cross town rival Camp Ojibwa. One of the many games scheduled was the 13A Hoops game. The game began as soon as we got to OJ. C.M. Started out with a bang as LARRY MILLER hit a huge "three" at the outset of the game. Then came some liquid sunshine and the game was postponed two minutes into the game with Menominee ahead 3-2. To bad it couldn't have ended there. The game resumed after dinner. C.M. played with full stomachs and came out slow. Ojibwa jumped ahead quickly, and it was difficult to come back. Starting along with MILLER was BRIAN ANDALMAN at point guard, who played inspired defense with his back courtmate JON JAPHA. Also stating in his rookie season, OREN JACOBSON and in the middle, COLIN TAHI. Off the bench came TODD RHEINGRUBER with some excellent defense and forced fouls on defense. Also contributing off the bench were: EVAN HERMAN, PHILIPPE IFERGAN, JAKE GOLDNER, KEI KATO, and MATT "CHICO" WEISS.

After the game the team talked about playing with "No Regrets!" We are keeping an eye toward the next competition with Ojibwa.

Green Men Make A Run

DOUG LEVIN & BRETT RHEINGRUBER—

At the beginning Menominee had a three point lead thanks to BRETT RHEINGRUBER's three-pointer. Then Ojibwa came back strong and took a seven point lead after the first quarter. In the second quarter the 11A, consisting of ELI PLATT, SCOTT SCHAFF, MIKE WEINER, JOSH BENJAMIN, ERIC STANG, MATT KLEIN, JARRET TURBIN, DOUG LEVIN, and BRETT RHEINGRUBER, began to fall apart as OJ took a big half time lead. In the third quarter, the offense was led by MATT KLEIN, MICHAEL WEINER, and ELI PLATT who played well down low. At the end of the third Menominee was down by 6. In the fourth, OJ went on a 12 to 2 run putting Menominee down by 16.

After that, Menominee played tough defense throughout the period and closed the lead. In the end however, the men in green fell short.

11C Hoops Tripped Up

JON KULESZA—

With uncertainty in the air due to the weather, we weren't sure if the games would be played. After a long, grueling, and emotional day, the 11C team came out after dinner and played their hearts out. Menominee had an early lead of 12 to 9. However, Ojibwa's defense started to click as we began to slow down. Everyone played hard and well, but over all, two guys really showed their stuff. JAY GUSTAFSON and BRIAN "Champ" SUMERS took charge early and held our slim lead. Unfortunately, the Menominee guys came up short in the end. Great game guys... We'll get 'em next time!

16B Buckets Beaten By Better Bombers

MATT PASSEN—

The Menominee 16B basketball team played a hard fought game versus Ojibwa. If it was not for a few missed lay ups and a big size differential between the teams, this game would have looked a lot closer on the scoreboard. RICKY KIRSCH and CORY PROVUS contributed to Menominee's score with their outside shots as MATT PASSEN, GREG ABRAMS, and LEONARD FIALHO played hard off the bench to make a couple of key shots. Menominee played well throughout the game but at the final buzzer they didn't come up on top.

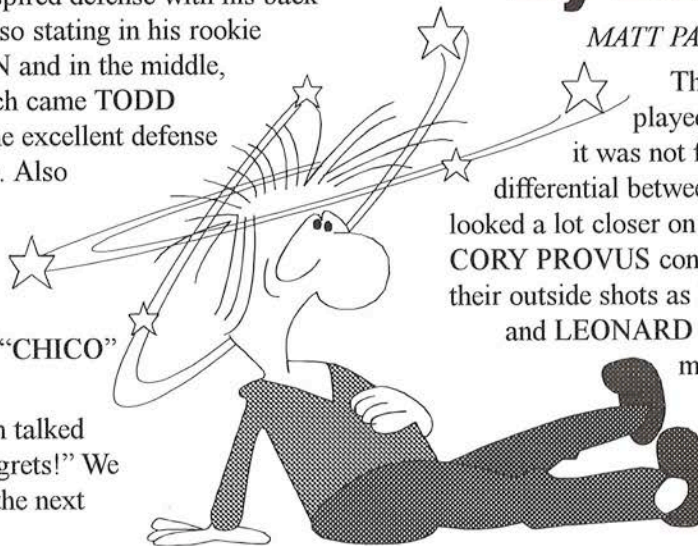

16C Hoops Helps Make "Coach-A-Cola" Happy

JON KULESZA—

I, JON KULESZA, have been involved in organized sports since I was seven years old. In all my years of playing, I have never been more surprised by a game than I was today! The 16C team faced a diamond and one monster press. We got down 22 points during a stretch between the first quarter and half-time. The biggest surprise was ELLIOT PESSIS playing defense like a man on a mission. He was fierce and played such a mean game. In addition, GABE POLSKY rebounded, scored, and played point guard. What a day! "SHOELESS" JOE JACKSON was hot during one of the periods as he hit 3 out of 5 three pointers! I was proud of all who played. They never gave up and cut the 22 point deficit to only a 9 point loss.



11B Pressed But Not Depressed

DANIEL ROSEN—

The game began - C.M.'s 11B vs. OJ's 11B. Menominee controlled the jump but Ojibwa stole it and got a quick two points. The first quarter ended with the score of 6-4 in favor of OJ. In the second quarter, JARED RALSKY provided a spark off the bench along with ERIC ISRAEL.

Even though Menominee found themselves down for most of the game, they continued to hustle. JUSTIN HOROWITZ pushed the ball up court to DANIEL ROSEN who hit a jumper that put a little life into the Menominee offense which had a tough time getting things past the OJ press.

In the end, the score, which favored OJ, did not account for the effort put in by C.M.'s 11B who never gave up.

11D Hoops Looks Forward To Rematch

ROSS AUSLANDER—

As the sun began to set on this wet Thursday night, the 11D basketball team took to the courts. They took to the newly designed and newly made far basketball courts on the Sport Rink. We were up and we were excited for the game. It was Ojibwa. The guys including starters JOE KLEIN, ADAM GREENBERG, BRAD ROSS, DAVID SCHWARTZ, and JORDAN ROTHSTEIN. As the game went on, everything started to flow together. We got some great help off the bench to get it started. Led by JARED OLIAN, JAKE KLEIN, and NICK TALBOT the bench provided strong support both physically and enthusiastically throughout the game. Unfortunately, our offense was not there. Our shots just were not going down. Sometimes games go like that, and the final score was 22-10 OJ. Our kids' heads were up and are ready for a re-match with OJ in the coming weeks.

Shorter 16 Hoopers Not Lacking Character

BARRY QUAYLE—

The 16A basketball game versus Ojibwa showed the character of an undersized Menominee team. Led by the spirited coaching of BARRY "BQ" QUAYLE, the Soaring Eagles took on OJ. The offense was led by the AUSLANDER brothers who sparked the teams intensity. JASON "THE BEAR" SCHWARTZ played tough defense throughout the game against a significantly taller OJ center and held him to a minimal offensive game.

11 Tennis Tough

MICHAEL WEINER—

On Wednesday, the 11 and under campers of Ojibwa came to Camp Menominee. The tennis matches were very exciting. There were many very close matches and we played as hard as we could. Our number one singles player,

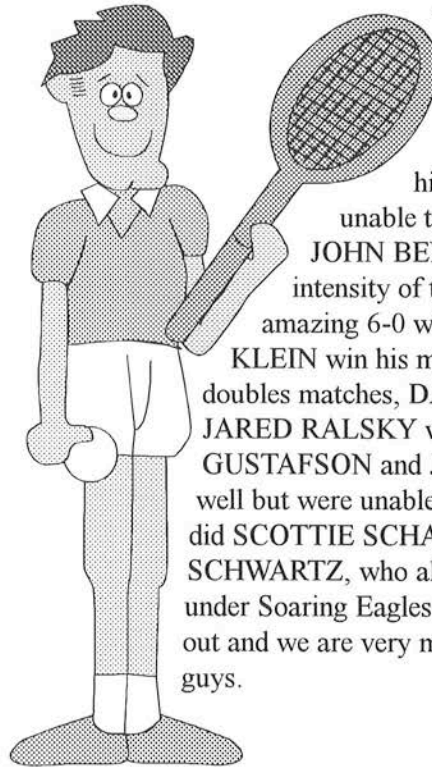

MICHAEL WEINER, lost 6-4, but he did put up an excellent fight. SAM

YUSPEH also played his hardest, but still was unable to win his match.

JOHN BENJAMIN, feeling the intensity of the racket, took an amazing 6-0 win! So did MATT KLEIN win his match 6-5. In the doubles matches, DAN ROSEN and JARED RALSKY won 6-2. JAY GUSTAFSON and JON SIEGEL played well but were unable to take the win. As did SCOTTIE SCHAFF and MATT SCHWARTZ, who also lost. The 11 and under Soaring Eagles played their hearts out and we are very much proud of you guys.

16 Tennis Victory Leads Seniors to Overall Win VS Ojibwa

CORY PROVUS—

For the 16 and under age group, tennis was the last event in a grueling day of competition versus Ojibwa. It was up to these ten players to determine the fate of the Senior Division. If they win, Menominee's Seniors win. If they lose, Menominee's Seniors lose. Playing #1 singles was ALAN TRUBOW who demonstrated his power and experience on the court as he cruised to an 8-4 victory. At #2 singles was CORY PROVUS. After a close and quick paced match, PROVUS won 8-6. Number two doubles was the team of JOSH "YOSH" ROTHENBERG and PHIL STERNHELL who defeated their OJ opponents 8-5. The number three doubles was played by the team of BRANDON SMITH and ADAM SCHREIER who came up just short, losing 8-6 after a tough match.

Due to a lack of light, the other matches that were scheduled were canceled. But Menominee did not mind this as they won 3-1 in the 16 and under tennis meet. This victory pushed the Menominee Seniors over the top in events 4-3.

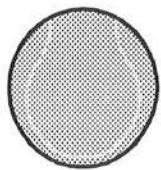

Tennis Saves The Day At OJ

ANDY ZLOTNIK—

As the evening came to a close in the Ojibwa compound, it was up to the 13 and under tennis team to keep Menominee from being swept in the age group. The meet started off with the singles competition. MATT ROTHSTEIN, PHILIPPE IFERGAN, and ALEX YUSPEH, all won their respective matches. After this outstanding start, the doubles teams faltered and at the end of six matches the meet's score was locked at 3 to 3. With the match on the line, ANDRES ARAIZA and JOSE BASAGOITI stepped up their games and demolished the OJ team in front of a huge OJ crowd, sending the Menominee Tennis Team home with yet another win, once again proving Menominee's dominance on the courts.



IIC Spells Victory Against O.J.I.B.W.A.

MARK CHAPIN—

Wow, what a game! The mean green machine of Camp Menominee took the field against O.J.I.B.W.A. on Thursday and left the field with an 11 to 7 intense victory. On the mound was BRIAN "CHAMP" SUMERS who pitched an outstanding game. Backing him up in the field were JARRET TURBIN at 3rd, JEREMY MATIMORE at short, JEFF STEIN as 2nd, ADAM GREENBERG at 1st, NICK TALBOT in right, JARED OLIAN in center, JOE KLEIN at short center, JESSE LATORRE in left, and A.J. STEIN behind the plate.

Outstanding hitting was done by all, but JEREMY MATIMORE stole the show with a grand-slam home-run in the fifth inning and a triple in the sixth. Great job JEREMY! DAVID SCHWARTZ had a couple of singles as did ADAM GREENBERG. (The bats are still smoking!!) An overall great effort by all! The defense would receive an A! I'm proud of you guys!

13B Willing To Give It Up

BRYAN SIMKIN—

The first inning in the 13B softball game started out with a bang. We did not get any runs, but PETER EHRLICH collided with JORDAN GAULE while going back on a fly ball in center field. Both players were fortunately all right after the incident.

During the game, the offensive attack was provided by TED ROTH, ANDERS JOHNSON, BRETT CHETEK, and BRYAN SIMKIN. The game was tied at six in the late innings when some poor defense that could have cost Menominee the game, but they never gave up. It was in the sixth inning when Menominee found themselves down 11-6, however the team could not score a run and went down in order in the top of the inning. The defense returned in the bottom of the inning as TODD BLOCK pitched superbly allowing no runs.

Even though the 13B was unable to comeback, we gave it our best effort, literally sacrificing our bodies.

13C Softball Never Gives Up

DAVE CHERNER—

It was drizzling outside and both the Menominee and Ojibwa 13C softball teams were getting ready for the game at OJ. They both had a lot of enthusiasm.

Menominee was up first and had a quick one, two, three inning. But, of course, nobody got down. Ojibwa went up to bat. A hit was made to left field. As JORDAN GAULE ran after it, PETER EHRLICH was running after a ball in the opposite directions from the B game, and they collided. This led to a decision to have the game moved to a different field.

The rest of the game for Menominee was defined by the trilogy, "Hit, run, and hustle." Ojibwa was getting hits and scoring runs, putting Menominee behind, but the C team was not about to give up. They kept their heads up the whole game and kept hustling.

In the end, Ojibwa won. It was a tough loss for Menominee's C softball team as they played a sound defensive game while never giving up hope.

With Spirits High, 13B Hoops Goes Down

ANDREW BENDER—

Menominee had an interesting game on Wednesday versus OJ in 13B basketball. We started off slow and in the second half made a great run.

In the first half OJ started off scoring six unanswered points. It then started to rain which allowed us time to think about what we did wrong and pull ourselves together. We came back with good ideas, but were still unable to run our plays against a solid OJ defense. Even though we were down by a lot at half, nobody gave up. We all kept our hopes up and still had high spirits. During the second half, our team hustled until they were ready to pass out. Everyone on our team dove on the floor and jumped for rebounds.

Nobody cared if they got cuts, because we played so we would have no regrets. Although we lost, we all walked off with smiles because we made a huge come back and we never gave up. We did the best we could. Our whole team was pleased with our second half play. If we had to do it again, we would have tried just as hard, win or lose.

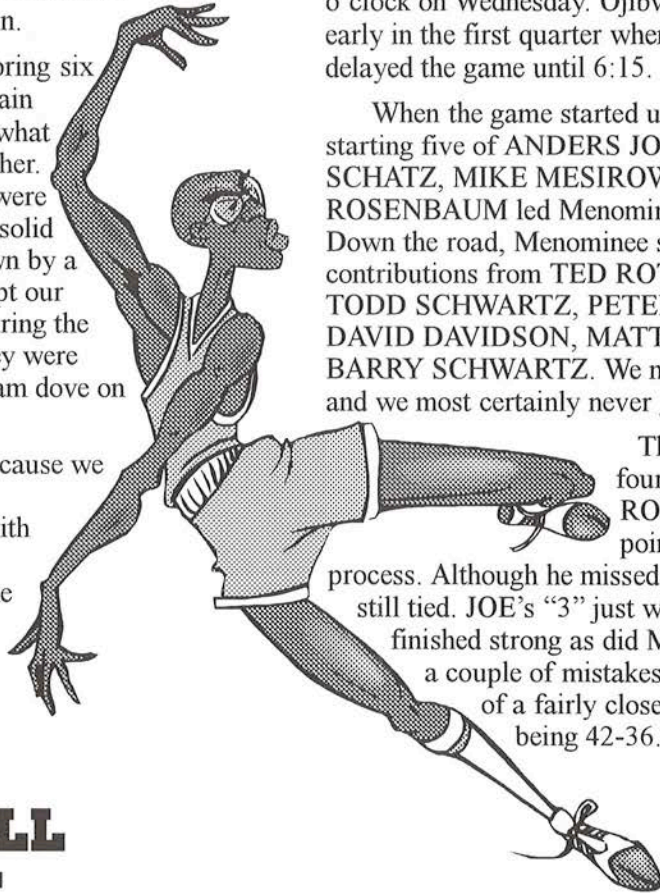

13C Cagers Cut-down

DAVID DAVIDSON—

The 13C basketball match started at about three o'clock on Wednesday. Ojibwa jumped out to a 6-3 lead early in the first quarter when the rain came, which delayed the game until 6:15.

When the game started up again, the Menominee starting five of ANDERS JOHNSON, JOHNNY SCHATZ, MIKE MESIROW, DANNY LEVY, and JOE ROSENBAUM led Menominee out to a six point lead. Down the road, Menominee still played well with contributions from TED ROTH, BRETT CHETEK, TODD SCHWARTZ, PETER BERNICK, RYAN HOLZ, DAVID DAVIDSON, MATT FRANK, JEFF DRITZ, and BARRY SCHWARTZ. We managed to stay in the game, and we most certainly never gave up.

Then with time down to about four minutes remaining, JOE ROSENBAUM drilled a three-pointer and got fouled in the process. Although he missed the free throw, the game was still tied. JOE's "3" just wasn't enough to win. Ojibwa finished strong as did Menominee, but we made just a couple of mistakes, and Ojibwa came out on top of a fairly close game with the final score being 42-36.

13D BASKETBALL DOES NOT QUIT

JASON "EDDIE" WHITE—

It was a hard fought battle that just didn't end our way. Outskilled and outmanned, the Menominee Team still didn't give up. It's a real shame that the score doesn't reflect the heart and the desire that the team had. The 13D Menominee basketball team deserved so much more. Our twin towers JOSH MERSFELDER and EVAN HARRIS provided most of the scoring, while ADAM KAPLAN provided outstanding ball handling when it was needed the most. TREVOR ABRAMSON, BRIAN WHITE, and HERBIE LUKES showed great hustle, while MATT FINDER, ETHAN HOROWITZ, and ANDY SLUSSER provided aggressiveness that helped to spark the team. All in all. This team had the potential for winning but just came up a little short in the end.

11A Score Not True Indication

FRANK JOHNSON—

It was an overcast day as the 11A softball team took the field against Ojibwa. Anticipation filled the air as MICHAEL WEINER three the first pitch of the game for the Soaring Eagles of Menominee. OJ jumped out to a quick 2-0 lead after one inning of play. However, in the bottom of the third, Menominee tied the game on a single by ELI PLATT. It was a defensive battle through the first five innings with SCOTT SCHAFF making great play after great play at shortstop for C.M. DANNY ROSEN and MATT KLEIN also sparkled in the field. IN the top of the sixth OJ busted the game wide open with hits and some miscues on Menominee's part. MICHAEL WEINER pitched a solid game and even though the score ended up looking like a blow out, OJ knows that it was a close game throughout.

11B Softball Shows Pride

ROB EMERY—

The 11B softball team took it on the chin against Ojibwa. The score was close during the first couple of innings. However, Ojibwa pulled away with the victory after they showed their power at the plate. 11B played

tough, kept their pride, and held their heads in the game. The pitcher, BRETT RHEINGRUBER, and the catcher, JOSH HELLER, provided great defense along with JOSH ZEMEL, JOSH BENJAMIN, JARED RALSKY, and ELLIOT LIEBERMAN.

16 ARCHERY ON TARGET VS OJIBWA

STEWART AUSLANDER—

As the highly confident archers of Menominee took to the targets they were met by a good team from Camp Ojibwa. Menominee had set one goal at this meet, and that was to end coach MIKE HOFF's brief losing streak against OJ. Otherwise meaning, they wanted to win. That is exactly what they did: Menominee's 518 to OJ's 411. EVAN ROSENBERG led the Soaring Eagles with a 94, then STEW "NATE" AUSLANDER shot a 92, followed by LEONARD FIALHO's 88, JEREMY FRYDMAN's 86, RICKY KIRSCH's 80, and AARON EAGLE's 78. To end the match with a little humor, KIRSCH shot his last arrow with the "Robin Hood" bow, and the 16 and under archery team had met its goal.

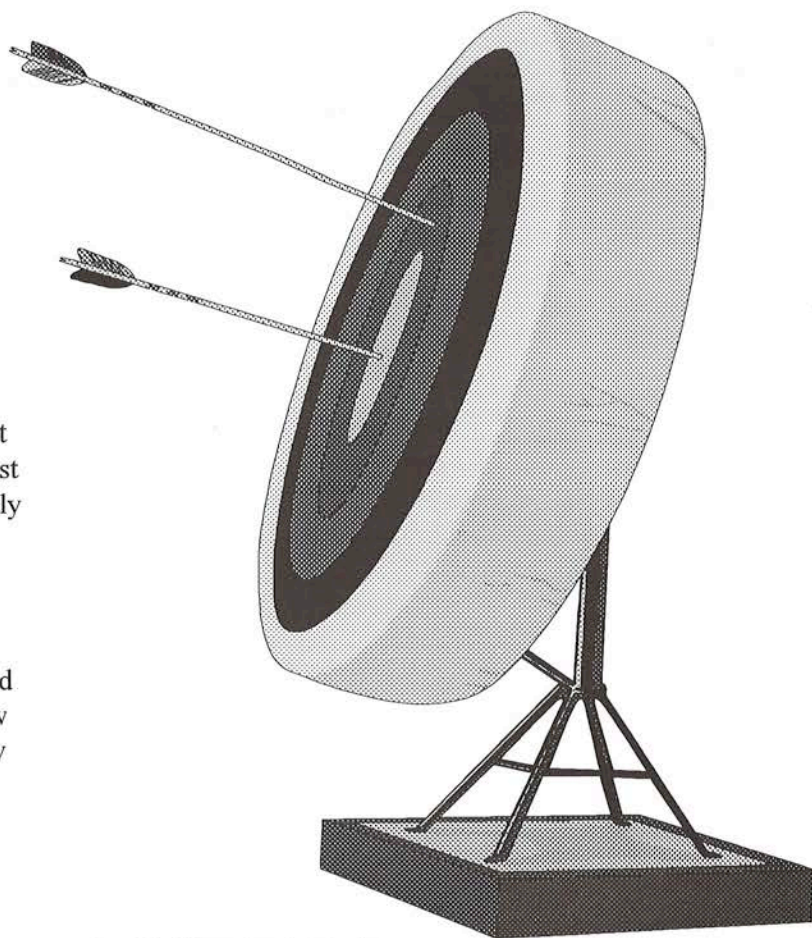

13 Archers Just Short

ANDREW PINGER—

High hopes were set for the 13 and under Ojibwa/Menominee team archery competition. Traveling to the "semi-friendly" confines of Camp Ojibwa, was the rookie scoring sensation HERBIE LUKES, accompanied by dead eyes ANDREW BENDER, STU EMMERMAN, and JEREMY GLAZMAN. Joining them was the southpaw wonder JON FELDMAN and the experienced range colossus, BRYAN SIMKIN. Earlier in the week, the six archers underwent a grueling selection process, consisting of innumerable six arrow rounds, laboriously brought on by the eighty degree heat. All six successfully dodged each of the coaches cuts to ultimately compete as a team at the unforgiving, yet calm, Ojibwa range.

LUKES led the team into the competition by chalking up a 48 in round one followed by a 36 in round two. His overall score of 84 tied him for second place within the team. Also shooting 84's were BENDER (38,46) and JEREMY GLAZMAN (42, 42). EMMERMAN came through with the mark of 66, just being beat by teammate JON FELDMAN's 67. SIMKIN naturally had a stellar performance shooting a 44 and then a 46. BRYAN was a bit shook up that he could not use the Browning, but made up for his disappointment in spirit, leadership, and enthusiasm.

For all of their heroics, the team still suffered a 25 point defeat. The final score: Menominee 475 - Ojibwa 500. Nice shooting Menominee. Ojibwa look out for next time.

NUTTER NOTCHES NINETY-EIGHT 11 & UNDER ARCHERY NAILS OJIBWA

SCOOTER GOLDNER—

The bows were tight, arrows were set, the string was slowly pulled back... quietly taking a breath... aiming carefully on target... then KERPLUNK!! A BULLSEYE!! This is how the scene took place as the Menominee Soaring Eagles shot at the targets during the 11 and under competition against Ojibwa. JAMES McGOVERN shot an amazing 96, which was actually better than some of the seniors who shot earlier that day. Our very own SCOOTER GOLDNER came right under him with a 92 using the Bear Bow. JOSH HELLER had tremendous spirits even though he only shot a 67. DOUG LEVIN also gave it his all and got an 82. But it was the rookie of the year, TOMMY NUTTER who wowed the crowd. He took home the win with an incredible score of 98!! Great job guys! Let's keep those arrows flying!!



MEGAPHONE

TOTALLY TEAMIN' EDITION

JULY 8-11, 1994



Softball Scenario Socializes Campers

SCOTT SCHAFF—

Last Thursday, Menominee took on Camp Timberlane in softball. We mixed teams so that some of the campers from Menominee played on the same team with Timberlane. Some of our players were: ERIC ISRAEL, JAKE KLEIN, JORDAN

ROTHSTEIN, ERIC STANG, and MIKE REICH. We numbered off by two's and the boys who were on the second team won. GREG ABRAMS and CORY PROVUS were the umpires. The game was well played by both teams. It was real fun and we met a lot of people.

Menominee And Timberlane Combine For Fun

MARK BEERMANN—

Thursday, the 12 and under boys of Menominee had a game mixed with the boys of Timberlane. One team called themselves Beers Bad Boys, and the other team were the Dan's Dirty Dogs; named after the respective coaches by umpire DENNIS "HOG" HOGLAND. DAN ROSEN pitched a fantastic game, while JORDAN GRANT, MATT FINDER, and JAKE NEIMAN, all hit very well at the plate. Also BRIAN SUMERS, JORDAN GRANT, BRIAN WHITE, JORDAN GAULE, JEREMY GLAZMAN, EVAN HARRIS, BRETT PESSIS, and JEFF HERTZ all did great field work. Every boy got along with the other guys from Timberlane. This game was a great example of how two camps can combine to have fun and compete. Beers Bad Boys did win with a 14-13 victory.

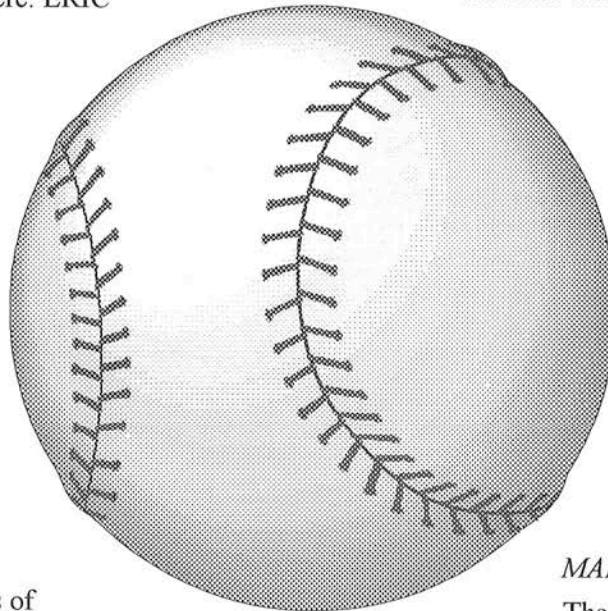

Chippy Almost Knocks-Off Opposite Handed Seniors

MARC BEERMANN—

The main object of the Menominee and Chippewa co-ed softball game was, of course, a good time and to socialize. This goal of fun was attained to the fullest as everyone had a great time. The boys from Menominee were hindered at the bat because they were required to bat with their opposite hand, and Chippewa took a 2-0 lead. Eventually, Menominee came back with three runs produced by ANDY SCHIMEL, JEREMY FRYDMAN, and TODD BLOCK. RICKY KIRSCH pitched a great game earning the "W". ELLIOT PESSIS, ADAM SCHREIER, and JOE JACKSON combined to play great defense. At the bottom of the last inning, Menominee was down by one run and JEREMY FRYDMAN saved Menominee pride by knocking in the winning run. Final score, Menominee 11, Chippewa 10.



12 & Under All-Stars Win In Historic Hardball Heartstopper

ARI BERNSTEIN—

On a beautiful Tuesday evening, our Menominee twelve and under Hardball team took on the St. Germain Sox for the second time this season. After being blown out in the first game, this time an All-Star team was ready for revenge. PETER BERNICK started on the mound and held the bulked-up Sox line-up at bay through three innings of work. BERNICK was supported by a solid defense which included MATT FINDER at first and JAKE NEIMAN in right. However, the game was not a pitching duel but an offensive exposition. SIM DARWICK, CHRIS CADY, PETER BERNICK, PETER EHRLICH, OREN JACOBSON, and DAVID KRAUT all had a multiple hit game.

BERNICK was relieved in the fourth by CADY who put a cap on the Sox offense allowing no runs and two hits in three innings. Spectacular defense off the bench helped to this end provided by MIKE WEINER's diving catch in left field, and BRAD MENDEL's great catch on a potential Texas leaguer in shallow right field.

The score was 8-5 going into the bottom of the fifth when the offense came to life once more. MIKE WEINER started a rally with a single followed by BRIAN WHITE's base rap. DAVID KRAUT then walked after coming from an 0-2 count, which loaded bases for BRAD MENDEL who hit a two RBI single. Going into the bottom of the sixth, it was 8-7.

SIM DARWICK led off with a single and was moved to third on a fielder's choice by EHRLICH. PETER BERNICK then hit a sac fly to score DARWICK from third tying the game at eight. With two outs, CHRIS CADY doubled and then proceeded to steal third on a wild pitch which set the stage for OREN JACOBSON. On a 2-2 count, JACOBSON hit a shot past the pitcher up the middle to score CADY. Menominee had won, 9-8.

The game brought out the best in the team not only physically but mentally as they were forced to overcome two deficits in the game. Coaches ROB EMERY and ARI BERNSTEIN could not have been more pleased with the performance of the team. Glenn, who umpired the game, said it may have been the greatest game in Menominee Hardball history. It was also the first ever Super Camp

victory on the New Al Lewis Field, and for this a ball will forever be displayed in Menominee's Balls of Fame in the Mess Hall.

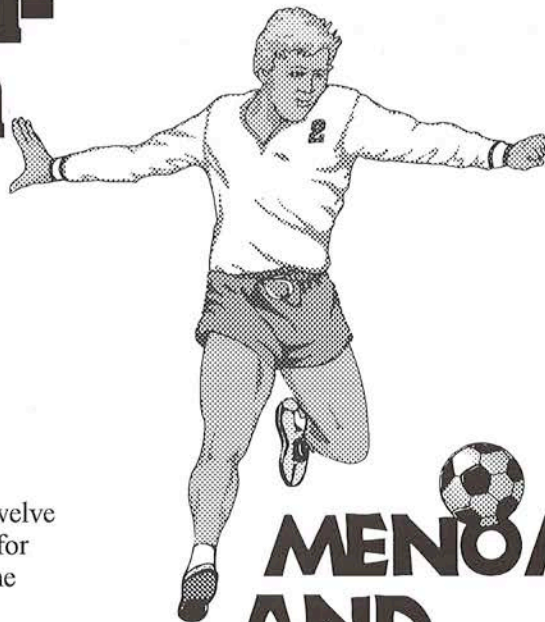

MENOMINEE AND TIMBERLANE BOTH COME UP WINNERS

JASON WHITE—

Great sportsmanship and great effort proved to win in the end. Seven guys from Camp Timberlane, sixteen guys from Menominee; together they played a great game of soccer. It's always nice to enjoy a friendly game with a neighboring camp. Excellent hosts and wonderful guests led to a very successful 12 and under soccer game. As for who won the game, well let's just say that both camps won in more ways than one.

CM And TL Join Forces

CRAIG ZIPPERER—

"All in fun" was the theme before, during and after the enthusiastic soccer match at Timberlane. The participants included eleven athletically skilled boys, 10 and under, from Menominee and two boys from Timberlane. Some of the players included were: JOE KLEIN, ERIC STANG, JOSH ZEMEL, HARRIS KEALY, JORDAN ROTHSTEIN, ANDREW DRAFT, JESSE LATORRE, J.D. McCORMICK, ROB KOHEN, and let's not forget FLETCHER and JOSH from Timberlane. I think I can speak for both the two players and coaches from Timberlane and all of us from Menominee when I say we look forward to doing that with other camps and again with them next year.

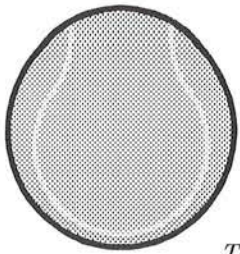

Tone's Tennis Team Takes Timberlane

TONE—

As C.M.'s 12 and under tennis team walked on to the tennis courts they oozed confidence and style. As the matches got underway, things were going according to plan. SIM DARWICK took a 2-0 lead, MIKE WEINER was up 4-0 while PETER EHRLICH and ETHAN HOROWITZ were up as well along with JOSH BENJAMIN and MATT KLEIN. Then, things started to change. DARWICK fell down 5-2, but stormed back to 5-4, then dropped two games. Down 7-4, DARWICK laid it on the line and tied the match at 7, sending it to a tie-break. SIM aggressively attacked the ball in the tie-break and finished off one of the greatest comebacks of the summer in tennis, earning a

victory 8-7. MIKE WEINER had no troubles however as he cruised to an 8-1 shellacking, enjoying every point of it. ELI PLATT who started playing tennis at the start of Camp put forth a solid effort, but came up just short, losing 8-5.

Back in the doubles competition, PETER EHRLICH and ETHAN HOROWITZ hit the ball hard, but the Timberlane guys pushed the ball into the gaps and we went down 8-5. JOSH BENJAMIN's and MATT KLEIN's match was never in doubt as they trounced their opponents 8-2, and won the meet for Menominee in doing so. In the final match, JAY GUSTAFSON and JARED RALSKY destroyed their opponents 8-1 with some great serve and volley doubles play. The meet was a great success.

'Cabin 14 Turns Smell Into Swell Top Ten List

GREG ABRAMS—

It was a normal afternoon at Camp Menominee on Wednesday. In the Mess Hall at lunchtime, however, a distinct aroma permeated through the air from an ill-timed septic tank emptying outside near the hall. This smell was so horrid that GLENN was prompted to ask each cabin to come up with a list of what are the top ten worst smells in camp. Some of the most disgusting and hilarious included ANDREW PINGER's sheets, a Metallica concert, FRANK JOHNSON, BARRY QUAYLE's underwear, toe cheese, and beanies and weanies. Cabin 14 was declared the winner with their odorific list of smells. Here we present the winning top ten smells:

10. Post TE Social Armpits
9. BEERMANN's Chest
8. Gary, Indiana
7. Cabin 15
6. Baby Isaac's Diapers
5. Philly's Dukers
4. GREG ABRAMS in his "office"
3. Flurry's tennis ball
2. The New York Knicks
1. Camp after weanies and beanies

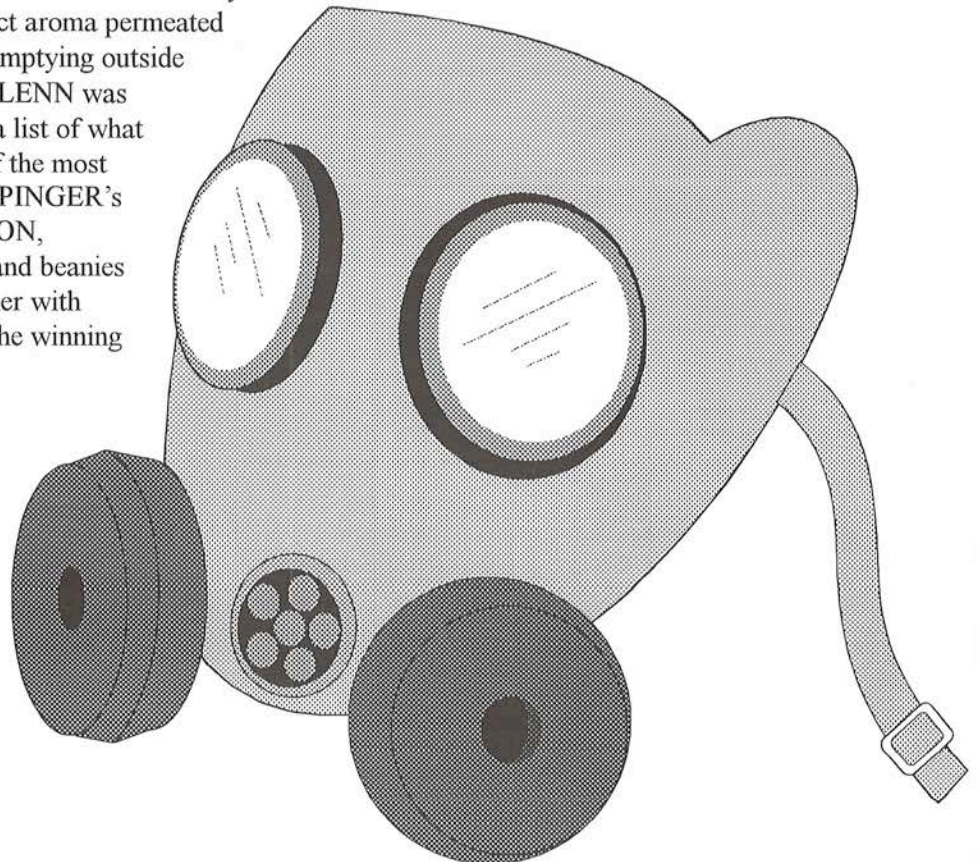

MEGAPHONE

WHAT A LONG STRANGE TRIP WEEK EDITION

JULY 12-13, 1994

Epic Voyage Not For The Faint Of Heart

ERIK "LLOYD" ECKBLAD—

After a hearty meal at the Friendly Confines, campers and counselors from cabins 9, 10, 14 and 15 embarked on an epic voyage. The canoe trip began on a cool, overcast afternoon with campers and counselors ready to take on the challenge of a lengthy paddle. A crew of JAKE MEILACH, MIKE MESIROW, STEPHEN STEIN, and MATT KAUFMAN even braved the waters on their own. The water was smooth for much of the day until the first set of rapids where GREG ABRAMS, JORDAN GAULE, ADAM KAPLAN, and ANDY SLUSSER were stuck on a rock. ROBERT "YEEE-HAAAAAAAHH" EMERY and his crew saved the day with ROB's leg being the only casualty. The rest of the trip was more peaceful with a hawk and eagle fight and several cranes flying overhead. Everyone had to give their all to finish the four hour trip.

We all landed and were greeted by a hot dog cookout. After that, everyone involved themselves in various games including Land and Paddleball with canoe paddles on a dirt road. Also, a game of cricket was started by BERNIE "NO GUTS NO GLORY" CUNNINGHAM. MANUEL ESCALANTE had an amazing debut with a six run strike on his first hit ever. Later that evening, DAWN arrived with a van load of Blizzards, easily the highlight of the trip.

Due to weather unfavorable to any outdoorsman, the remaining six hours of the trip remained unfinished. The next morning a bus came to pick everyone up and bring them back to camp with a stop off at McDonald's on the way. Everyone enjoyed a "real" rest period that afternoon.



Canoers Make Memorable Journey

CARL "RAWHIDE" ROWLAND—

It was midday when the canoe trip left Sand Lake for its destination, a campsite four miles across Dam Lake and down the Wisconsin River. All were excited about the trip and could not wait to get there. RAWHIDE's canoe led the mass convoy of canoes across Sand and Dam Lake. Strong winds made crossing Dam Lake a hard task. The first waves was TRUBOW's laugh at this

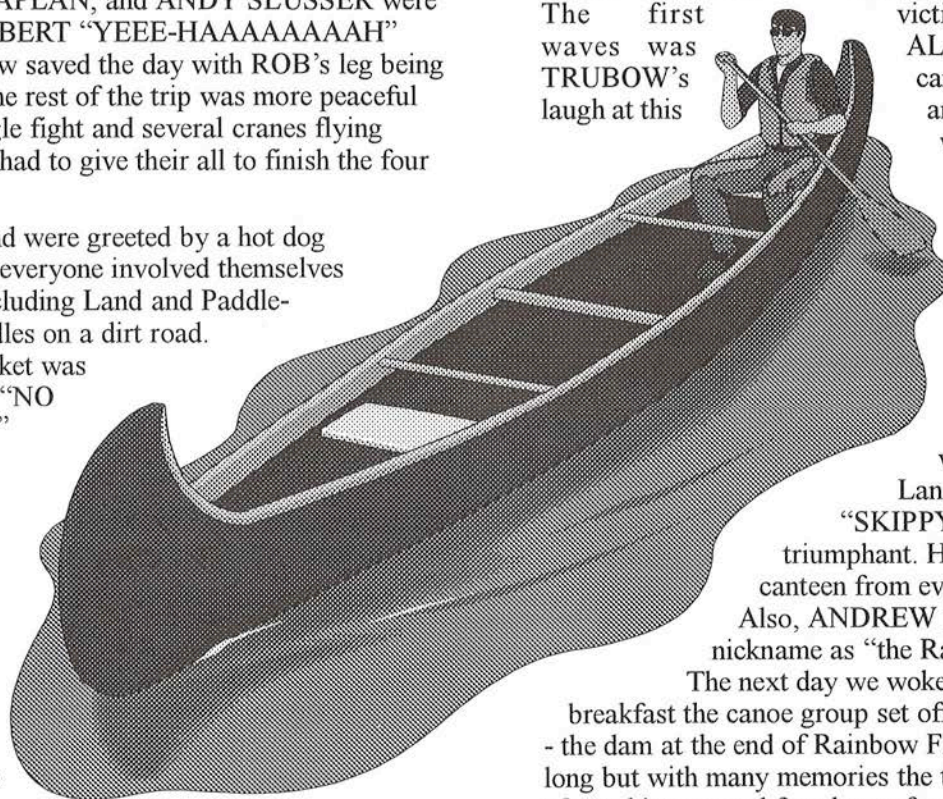

victim to capsize under large ALAN "BONER" canoe. Everybody had a and in the end they all went on safely. Once at the campsite, the group had a spitting competition off the bridge over the dam. The winner with an amazing long (but with finesse) spit was BRETT "SCOOTER" GOLDNER. Next up was a massive game of

Land with DANIEL "SKIPPY" ROSEN winding up triumphant. He won himself a free canteen from every counselor on the trip. Also, ANDREW PINGER gained a nickname as "the Ranger!"

The next day we woke up and after a hearty breakfast the canoe group set off for the next destination - the dam at the end of Rainbow Flowage. The trip was long but with many memories the trip passed quickly, even after taking around four hours for the convoy to arrive at the dam.

This year's canoe trip was great and many memories were made.

Juniors Pet At Peck's

DOUG LEVIN—

Peck's is a great place for those interested in animals. At Peck's they let deer roam freely to pet and feed. They also have ducks, rabbits, ground hogs and various other forms of wildlife in their natural habitats. They also had an exciting presentation about the red owl! Kids in the Junior cabins had a great time, like JOSH ZEMEL, HARRIS KEALEY, ANDREW DRAFT, JUSTIN HOROWITZ, and many others. Also, BRYAN WHITFORD, GAVIN SPOWAGE, MARCUS ZAVOS, BARRY QUAYLE, and JASON SCHWARTZ were the counselors on the trip.

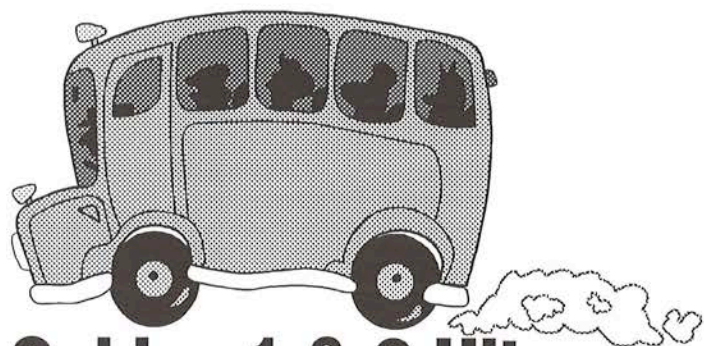

Cabins 1 & 2 Hit The Twin Cities

MATT "CHICO" WEISS—

We left the Friendly Confines of Camp Menominee at about 9:30 a.m. for the city of Minneapolis, Minnesota. On the way we stopped for lunch at Hardee's in Ladysmith, Wisconsin. Ready to depart and continue on to the Twin Cities we had a scare. The bus died, but thanks to AARON "SKINDER" PERNA's prayer we continued. We arrived in Minneapolis at about four o'clock in the afternoon. Due to rain we postponed the trip to Valley Fair Amusement Park and went to the famous and enormous Mall of America. At the mall we found ourselves amazed at how much there was to do. Everyone went on the roller-coaster and the most popular store was Champs sports. When we went back to our hotel, the Super 8, we ate pizza and went to bed.

The next day started with a fun filled morning at Valley Fair. They had many roller-coasters and other great rides. Then we went back to the Mall and finally to the Hubert H. Humphrey Metrodome to see the Minnesota Twins play the Milwaukee Brewers. It was a close game but the Brewers took it in the 9th, winning 6-4.

We woke up and departed from the Twin Cities early the next morning. A good time was had by all. Thanks for a great trip GLENN, DAWN, and KOZ.

JOE ROSENBAUM, JORDAN GOLDFARB and TODD RHEINGRUBER smile for ANDY ZLOTNIK's camera during the Dells trip



Young Seniors Do The Dells Look Forward To Minneapolis

DEAN ANDREW—

There is no better way to break up camp than a trip to the Wisconsin Dells. Counselors ZIP, FRANK, JONNY K. DEAN, and the "tripmaster" CHAPS, could not of been happier with the way the 38 boys from cabins 11, 12, 16 and 17 behaved.

There is so much to do in the Dells, so there was never a dull moment as we all crammed in as many activities as possible.

The opener was a trip to "Family Land." A great park within walking distance of our motel. The boys generally stuck with the hairier of the rides, i.e., the Devil's Drop.

The funniest moments of the Dells trip was the eight car smashup derby at the GoKarts. JON KULESZA did not know what he got himself into when he took on TODD and SETH RHEINGRUBER, LARRY MILLER, and JORDAN GOLDFARB. When you are go-carting on a slick track, counselor seniority is non-existing, and of course the boys made the most of this opportunity.

Wednesday was a big day. The whole day was spent at "Noah's Ark", and an evening at Tommy Bartlett's Ski Show. "Noah's Ark" is awesome; great rides and lots to do. Of all the rides at "Noah's Ark", the "Plunge" was the unanimous favorite.

Although the weather was less than friendly, the kids all had a great time. All of the boys had their candy, TV, and telephone "fixes", and talk on the bus ride home was about the Minneapolis trip next year.



Senior Cabin Chalks Up Best Trip Ever

MATT PASSEN—

The Senior Cabin had a great trip filled with excitement. They started off white water rafting with Big Smokey Falls down the Wolf River. The rapids were great along with the rest of the trip. After the four and a half hour rafting trip the Senior Cabin hopped on the van and drove to Green Bay, home of Lambeau Field and the Packer Hall of Fame. After a hard day of rafting, the Senior cabin ate dinner and went to bed at their hotel. The next day they made their way to Door County and went to an amusement park filled with water slides, go-carts, games, and a haunted house. They were animals on the go-cart track and definitely impressed by the haunted house. JEFF DAVIDSON managed to beat out "Ol' dead eye" BOBBY GOODMAN in a shooting game and took home a Harley Davidson Bear. Next, the Senior Cabin went shopping around town and in the local mall. REID BARTHA acquired some nice looking T-shirts and JOSE VILLAVICENCIO got a new wardrobe.

The next day, after some more shopping, we went go-carting on an extra slick track due to the rain. MARC BEERMANN drew sparks on PHIL STERNHELL and JEREMY FRYDMAN got bruised by MATT PASSEN. EVAN ROSENBERG was at the bottom of the food chain and stayed basically out of trouble. After their go-carting expedition, the Senior Cabin went to the Packer Hall of Fame. No one got left behind, unlike last year, but it was still great. We tested our throwing skills in the throwing room and watched Packer movies and saw Packer memorabilia.

After a great three days, the Senior cabin had had the greatest trip of their camping experiences.

Meta Mixer Makes Memories

HERBIE LUKES—

After having the traditional July 4th social with Camp Marimeta rained on, the boys of Menominee looked forward to a second social with Marimeta. It came a week later on July 11th and was fantastic. Later in the evening, the fireworks were set off, and they were amazing. All in all, this social was loads of fun.



JON JAPHA and TODD SCHWARTZ socialize after an intense Team Menominee Soccer game during the Marimeta social. Team Menominee



TWO C.M.S TIE AT TWO

ZIP—

For many of us (Counselors and Campers) there were two important events occurring in 1994. These two were Cam and the World Cup. Some of us here were fortunate enough to attend both but for those who were not so lucky the spirit of the Cup could be felt, tasted, and heard during the Meta vs. Menominee soccer game. The event took place on the newly constructed soccer pitch here at the Friendly Confines. The team was split in half with experience. Rookies of Team Menominee included: STEW and ROSS AUSLANDER, ALAN TRUBOW, "DOOGIE" BELCHER, ANDREW PINGER, GAVIN SPOWAGE, JASON "EDDIE" WHITE, DROR NAFTALY, CARL ROWLAND, and JOSH ROTHENBERG. The veterans included such All-Stars as: ROSS ALLEN, MARC "CHAPS (OR CHEEPS)" CHAPIN, ZIP, TONE, and ANDY ZLOTNIK. It was hard to find a weakness in either of the teams. The game was as intense as it could of been: maybe even a bit too much. By the end of the first half, Meta somehow found a way to creep through our defense and score two goals. It was not until the middle of the second half when DOOGIE confronted the Meta goalie with a precisely placed shot in the right lower corner of the goal, which blazed passed the goalie. It was then that spirits and

hopes were raised, and visions of sugar plum fairies danced in our heads. A victory was definitely in sight.

With under five minutes remaining, the tempo of the game dramatically increased. With possession constantly exchanging, Team Menominee's defense, directed by Mr. ROSS ALLEN, stopped every one of Meta's attempts to seal the victory. With a slight adjustment up front, moving TONE and ZIP ahead, gaps in

Meta's defense started to appear. With the crowd never losing hope, a pass out of the midfield was received by ZIP who instantly escorted it to the back of the net. With the score tied at two, the final whistle sounded. For the second year in a row, the Marimeta vs. Menominee soccer game ended with a victor - an unannounced victor.

MEGAPHONE

DEERHORN DIAMOND EDITION

JULY 14, 1994



10 Bombers Dive In 7th

ROB EMERY—

The intensive ten and under B softball game at Deerhorn ended with a line drive up the middle in the bottom of the seventh. Deerhorn pulled off the close win after Menominee displayed exceptional play on the field. ANDREW DRAFT pitched like a pro and hit a home run. SCOTT SCHAFF led the team on the field by playing superb defense and by helping keep everyone focused. ADAM GREENBERG kept every Deerhorn batter nervous by controlling first base. The B team showed great pride and played with enthusiasm.

aggressively as they stole a total of ten bases during the game.

The victory shoed once again Menominee's fantastic hardball program in action.

Finder Produces Winning RBI Soaring Eagles In Hardball Sweep vs. Deerhorn

BRETT CHETEK—

Menominee 6, Deerhorn 2. This score represents the Menominee 12 and under hardball team's third victory out of three games versus Camp Deerhorn.

CHRIS CADY pitched a solid six innings, striking out 8 Deerhorn batters with several one, two, three innings. Filling out the battery was PETER EHRlich who caught a fantastic game and threw out two base runners stealing during the game. The infield was solid with DAVID KRAUT at third, BRETT CHETEK at short, BRIAN WHITE at first, and NICK TALBOT at second. Off the bench came MIKE HIRSCH, who tripled, MATT FINDER, who had what would be the game winning RBI, BRIAN "CHAMP" SUMERS, and MARTY WEISMAN. The coach of the team was ARI ROSEN. He had a great attitude and effective strategy that led Menominee to victory.

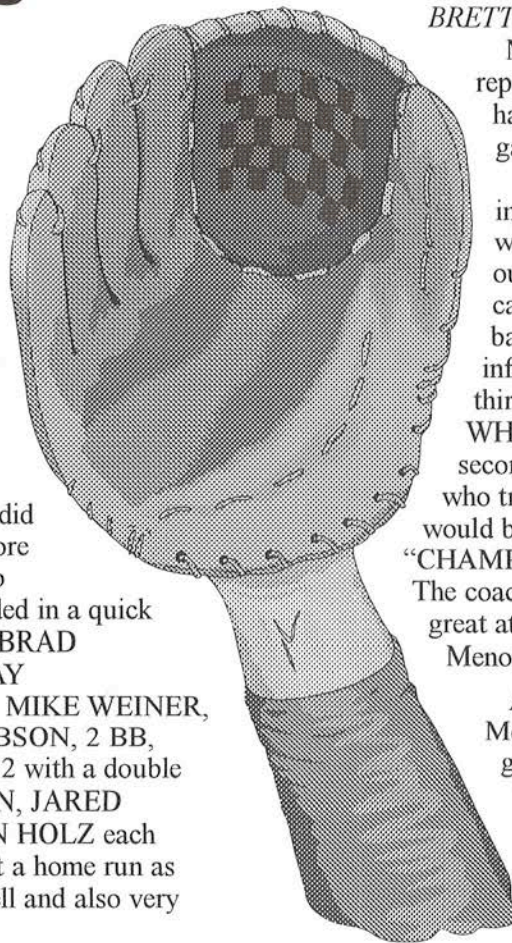

As one can see, the 12 and under Menominee Hardball Team did not win three games by chance against Deerhorn, but they won because they had better attitudes, hustled more, were better coached, and had pride for the Menominee Soaring Eagles.

BERNICK Hits Grand Slam In C.M. Slugfest

STEW AUSLANDER—

It was a beautiful day for baseball when Menominee matched up against Deerhorn in 12 and under hardball. Deerhorn jumped into the lead quickly, 1-0. Then Menominee came to bat. After one out, the rally started. The scored at the end of an inning: 11-1 Menominee. The next inning Deerhorn did not score and Menominee ran off 10 more runs. Once again, Deerhorn fell short to Menominee in hardball as the game ended in a quick slaughter rule. Here are the final stats: BRAD MENDEL, 0-1, BB, one run scored; JAY GUSTAFSON, 2 BB, two runs scored; MIKE WEINER, 2 singles, scored 2 runs; OREN JACOBSON, 2 BB, scored 2 runs; PETE BERNICK, 2 for 2 with a double and Grand Slam; JEREMY GLAZMAN, JARED RALSKY, BRETT PESSIS, and RYAN HOLZ each scored twice. ETHAN HOROWITZ hit a home run as well. In all, Menominee played very well and also very



Menominee Hardball Three Better Than Deerhorn

FRANK JOHNSON—

It was chilly, yet warmth filled the day as Menominee took on Deerhorn in hardball out on the New Al Lewis Field. Menominee jumped on Deerhorn quickly with eight runs in their half of the first inning. DANNY ROSEN had an RBI double while JOSH BENJAMIN and ELLIOT LIEBERMAN both added two run singles. SCOOTER GOLDNER, who had a triple to lead off the first, capped off the inning by hitting a three run inside the park home run. JOEL SORINSKY pitched three inning of shutout baseball, but then found himself in trouble in the fourth. However, after four innings, Menominee led 12-7. SIM DARWICK added a home run to put Menominee up 13-7. JORDAN GRANT, who also had a two run single earlier in the game, came in relief of SORINSKY and pitched the fifth and sixth innings and held off a late Deerhorn rally to win by the score of 13-10.

10A SB Comes Back For Big Win Against Deerhorn

BRETT RHEINGRUBER—

The first inning of the 10A softball game versus Deerhorn saw Deerhorn taking a 4-0 lead over Menominee. The next inning Menominee began to chip away at that lead scoring one run. Throughout the first five innings BRETT RHEINGRUBER pitched phenomenally allowing only the four runs in the first inning, walking on one and striking out five Deerhorn batters. At the end of five, the score was 6-4 in favor of Menominee. Menominee's potent offense was led by JOSH ZEMEL, ROB KOHEN, JEREMY MATIMORE, and JORDON ROTHSTEIN who helped to put Menominee into a eventual 9-6 lead. In the sixth inning, MIKE REICH came in to pitch. He retired the side one, two, three with some great defense provided by ERIC ISRAEL, JUSTIN HOROWITZ, and JEREMY EMER. In the bottom of the seventh, MICHAEL HERTZ came in relief of REICH. HERTZ walked the first batter and then proceeded to retire the side in order.

Menominee was victorious 9-6 over Deerhorn. Everybody on Menominee contributed and played a great game.

WATERFRONT PICTURE ARRAY.

V BERNIE CUNNINGHAM cuts around a buoy during the twi-light hours at C.M.



^ROSS ALLEN has a commanding view of the waterfront.

^JEFF J. DAVIDSON cools off in Sand Lake on a hot day.

^PHIL STERNHELL rides the wake while kneeboarding.



MEGAPHONE

MCAA - IN THE HOUSE EDITION

JULY 15-17, 1994



MCAA Explodes Into Action In '94

After a lengthy secret draft in each league of the MCAAs, the teams were set for this year's action. The Menominee Intense Soccer League (MISL) features three divisions with a total of nine teams. Commissioner CRAIG ZIPPERER predicts a fast paced season in tandem with this year's interest in the World Cup Finals. The MISL season will climax with the Menominee World Cup Championships.

In the Menominee League of Baseball (MLB), the all new Al Lewis Field will show itself off as being the finest hardball facility in the North Woods. Expectations are high heading into the season and commissioner FRANK JOHNSON sees a highly competitive and fun filled season ahead with three divisions with a total of

eleven teams.

For the first time ever in C.M. history, the Menominee Hockey League (MHL) will take to the new roller rink at the Friendly Confines.

The league, headed up by commissioner BRYAN WHITFORD, features three divisions with ten total teams and 66 players in all. The play should be fast paced.

The Menominee Basketball Association (MBA), under the direction of commissioner BARRY QUAYLE, will take to Menominee's hoops courts this summer for its third season. Never before have such numbers turned out. On seventeen teams there are one hundred and twelve players! With a full season of games slated, the MBA looks forward to its greatest season ever.

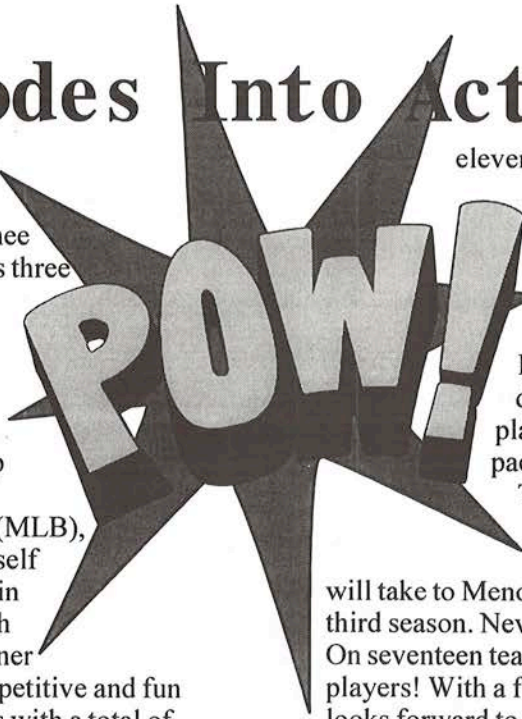

ROSTERS

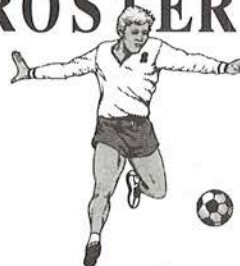

MISL

Division 1

LAZIO

JOE KLEIN
ROB KOHEN
JORDAN ROTHSTEIN
ERIC STANG
JOSH ZEMEL
Coach: SCOTT KAPLAN

ARSENOL

ANDREW DRAFT
HARRIS KEALEY
JESSE LATORRE
J.D. McCORMICK
JUDAH KLEIN
JOSH ROTHENBERG
Coach: CRAIG RASHKOW



MISL

Division 2

LIVERPOOL

BRETT CHETEK
ADAM KAPLAN
ELLIOT LIEBERMAN
BRAD MENDEL
JAKE MEILACH
ANDY SLUSSER
JAMEY STENGEL
RENE HERTSBERG
Coach: *ANDY ZLOTNIK*

REAL MADRID

PETER BERNICK
PETER EHRLICH
DAVID SCHWARTZ
STEPHEN STEIN
MIKE WEINER
BRETT RHEINGRUBER
SCOTT SCHAFF
Coach: *ANDREW PINGER*

GLASGOW RANGERS

JOSH BENJAMIN
MATT BERCOVITZ
BRETT GOLDNER
JAY GUSTAFSON
CASEY HINTZ
BRETT PESSIS
COLIN WEINER
MARTY WEISMAN
JAVIER BASAGOITI
Coach: *CRAIG ZIPPERER*

FC JERUSALEM

JEFF HERTZ
MICHAEL HIRSCH
RYAN HOLZ
OREN JACOBSON
JUSTIN MATIMORE
JOEL SORINSKY
JEFF STEIN
PABLO MAYO
JEREMY MATIMORE
Coach: *STEW AUSLANDER*

Division 3

AC MILAN

CHRIS CADY
DAVE CHERNER
JEFF DRITZ
LARRY MILLER
CRAIG RASHKOW
TED ROTH
JOHNNY SCHATZ
COLIN TAHI
ZACK WEINER
Coach: *CRAIG ZIPPERER*

MANCHESTER UNITED

JAKE GOLDNER
NICK HOUCHENS
JON JAPHA
SCOTT KAPLAN
RICKY KIRSCH
SETH RHEINGRUBER
JOE ROSENBAUM
ALEX YUSPEH
Coach: *ANDY ZLOTNIK*

SAMPDORIA

ANDREW BENDER
JORDAN GOLDFARB
EVAN HERMAN
MATT PASSEN
GABE POLSKY
EVAN ROSENBERG
BRIAN SIMKIN
PHILIP STERNHELL
HERBIE LUKES
Coach: *JASON WHITE*



Eastern Division

ORIOLES

ANDREW DRAFT
JOSH HELLER
JUSTIN HOROWITZ
ERIC ISRAEL
HARRIS KEALEY
JOE KLEIN
JUDAH KLEIN
ROB KOHEN
ERIC STANG
JOSH ZEMEL
Coach: *FRANK JOHNSON*

YANKEES

BRANDON DAVIS
JEREMY EMER
JAKE KLEIN
J.D. McCORMICK
JAMES McGOVERN
JARED OLIAN
MIKE REICH
JORDAN ROTHSTEIN
MATT SCHWARTZ
A.J. STEIN
JESSE LATORRE
Coach: *ARI BERNSTEIN*

Western Division

RANGERS

TREVOR ABRAMSON
MATT COHEN
JOHNNY SCHATZ
EVAN HERMAN
BRYAN SIMKIN
TODD RHEINGRUBER
BRIAN ANDALMAN
BRANDON SMITH
RICKY KIRSCH
Coach: *ROB EMERY*

MARINERS

ANDERS JOHNSON
JOE ROSENBAUM
TED ROTH
COLIN TAHI

PHILIPPE IFERGAN
JORDAN GOLDFARB
BARRY SCHWARTZ
ADAM SCHREIER
JON JAPHA
JEREMY FRYDMAN
Coach: *ARI BERNSTEIN*

A's

SETH RHEINGRUBER
HERBIE LUKES
MATT ROTHSTEIN
ANDREW BENDER
BRIAN TEPPS
BRAD BROOK
TODD SCHWARTZ
ELLIOT PESSIS
TODD BLOCK
AARON EAGLE
Coach: *FRANK JOHNSON*

Central Division

WHITE SOX

MATT HOLLANDER
JEFF STEIN
DANNY ROSEN
JEFF DAVIDSON
TOMMY NUTTER
SIM DARWICK
JORDAN GAULE
ANDY SLUSSER
JEFF HERTZ
Coach: *ARI BERNSTEIN*

INDIANS

BRANDON LEVY
JAMEY STENGEL
ELI PLATT
JAY GUSTAFSON
MATT BERCOVITZ
ETHAN HOROWITZ
MIKE WEINER
BRAD MENDEL
RYAN HOLZ
Coach: *FRANK JOHNSON*



ROYALS

ELLIOT LIEBERMAN
ADAM WEINGARTEN
JARED RALSKY
JOSH BENJAMIN
SCOTT SCHAFF
EVAN HARRIS
BRIAN WHITE
MIKE HIRSCH
JOEL SORINSKY
Coach: *ROB EMERY*

BREWERS

BRIAN SUMERS
DOUG LEVIN
JARRET TURBIN
MIKE HERTZ
MATT FINDER
PETER BERNICK
JORDAN GRANT
KEANAN LEVANT
JEREMY GLAZMAN
Coach: *JASON SCHWARTZ*

TWINS

BRAD ROSS
MATT KLEIN
BRETT RHEINGRUBER
ADAM GREENBERG
MARTY WEISMAN
CHRIS CADY
ADAM KAPLAN
STEPHEN STEIN
JUSTIN MATIMORE
BRETT CHETEK
Coach: *GREG ABRAMS*

TIGERS

SAM YUSPEH
JEREMY MATIMORE
NICK TALBOT
BRETT GOLDNER
BRETT PESSIS
JASON KUMMER
PETER EHRLICH
JAKE NEIMAN
OREN JACOBSON
Coach: *MIKE BURLING*



Conn Smythe Division

JETS

ANDREW DRAFT
HARRIS KEALEY
JAMES McGOVERN
JORDAN ROTHSTEIN
MATT SCHWARTZ
JOSH ZEMEL
Coach: *BRYAN WHITFORD*

KINGS

JEREMY EMER
ERIC ISRAEL
ROB KOHEN
JESSE LATORRE
J.D. McCORMICK
Coach: *MARC BEERMANN*



Norris Division

REDWINGS

BRETT CHETEK
SIM DARWICK
PETER EHRLICH
JASON HORN
BRAD MENDEL
JON SIEGEL
MARTY WEISMAN
Coach: *ANDY PINGER*

BLACKHAWKS

MATT GOODSTEIN
CASEY HINTZ
MATT KLEIN
JASON KUMMER
JUSTIN MATIMORE
JARED RALSKY
Coach: *STEWART AUSLANDER*

BLUES

MATT BERCOVITZ
JOSH BENJAMIN
JEREMY GLAZMAN
EVAN HARRIS
ELLIOT LIEBERMAN
DANIEL ROSEN
JOEL SORINSKY
Coach: *ROSS AUSLANDER*

NORTHSTARS

JAY GUSTAFSON
OREN JACOBSON
ADAM KAPLAN
KEANAN LEVANT
BRETT PESSIS
DAVE SCHWARTZ
ANDY SLUSSER
Coach: *BRYAN WHITFORD*

MAPLE LEAFS

PETER BERNICK
JORDAN GAULE
STEVE GOLER
RYAN HOLZ
JEREMY MATIMORE
JARRET TURBIN
Coach: *JASON SCHWARTZ*

James Patrick Division

DEVILS

BRIAN ANDROW
HERBIE LUKES
JOSH MERSFELDER
GABE POLSKY
TED ROTH
BARRY SCHWARTZ
PHILIP STERNHELL
Coach: *BRYAN WHITFORD*

RANGES

BOBBY GOODMAN
MATT GROSS
EVAN HERMAN
NICK HOUCHENS
MATT PASSEN
SETH RHEINGRUBER
JOE ROSENBAUM
Coach: *ARI ROSEN*

PENGUINS

BRAD BROOK
JEFF DAVIDSON
RICKEY KIRSCH
TODD RHEINGRUBER
EVAN ROSENBERG
MATT ROTHSTEIN
TODD SCHWARTZ
Coach: *ANDY BULLOCK*



Eastern Division

KNICKS

JEREMY EMER
JUSTIN HOROWITZ
JAKE KLEIN
JESSE LATORRE
J.D. McCORMICK
Coach: *BARRY QUAYLE*

CELTICS

JOE KLEIN
ROB KOHEN
JARED OLIAN
ERIC STANG
JOSH ZEMEL
Coach: *ARI ROSEN*

HEAT

ANDREW DRAFT
HARRIS KEALEY
JUDAH KLEIN
MICHAEL REICH
JORDAN ROTHSTEIN
Coach: *JASON SCHWARTZ*

Central Division

PISTONS

JAY GUSTAFSON
RENE HERTSBERG
ETHAN HOROWITZ
ELI PLATT
JON SIEGEL
JOEL SORINSKY
BRYAN SUMERS
ADAM WEINGARTEN
Coach: *MIKE BURLING*

BUCKS

MATT BERCOVITZ
PETER EHRLICH
JORDAN GAULE
RYAN HOLZ
NICK TALBOT
BRIAN WHITE
SAM YUSPEH
BRIAN ZAANDER
Coach: *JASON BELCHER*

HAWKS

JOSH BENJAMIN
BRETT CHETEK
KEANAN LEVANT
DOUG LEVIN
MIKE MESIROW
ANDY SLUSSER
JARRET TURBIN
Coach: *CORY PROVUS*

PACERS

JASON HORN
OREN JACOBSON
JEREMY MATIMORE
BRETT PESSIS
BRAD ROSS
JAMEY STENGEL
Coach: *STEW AUSLANDER*

HORNETS

PETER BERNICK
MATT FINDER
JORDAN GRANT
JUSTIN MATIMORE
JAKE NEIMAN
DAVID SCHWARTZ
COLIN WEINER
Coach: *ROSS AUSLANDER*

RAPTORS

EVAN HARRIS
MATT HOLLANDER
ADAM KAPLAN
MATT KLEIN
JAKE MEILACH
BRAD MENDEL
DANIEL ROSEN
Coach: *JASON SCHWARTZ*

CAVALIERS

SIM DARWICK
STEPHEN GOLER
MIKE HERTZ
MIKE HIRSCH
DANNY LEVY
JARED RALSKY
MIKE WEINER
Coach: *MARK CHAPIN*



Midwestern Division

ROCKETS

JEFF DAVIDSON
ROSS EDWARDS
JORDAN GOLDFARB
MIKE MASON
LARRY MILLER
JOE ROSENBAUM
JOHNNY SCHATZ
Coach: BARRY QUAYLE

SUNS

TREVOR ABRAMSON
DAVID DAVIDSON
EVAN HERMAN
KEI KATO
JOSH MERSEFELDER
TODD RHEINGRUBER
MATT ROTHSTEIN
Coach: *ARI ROSEN*

NUGGETS

ANDERS JOHNSON
SETH RHEINGRUBER
CRAIG RASHKOW
TED ROTH
BERRY SCHWARTZ
BRYAN SIMKIN
ALEX YUSPEH
Coach: *ALAN TRUBOW*

SPURS

TODD BLOCK
BRAD BROOK
LEONARD FIALHO
ANDREW BENDER
MATT FRANK
BRAD MOSS
TODD SCHWARTZ
COLIN TAHI
Coach: *JASON BELCHER*

Western Division

LAKERS

JEREMY FRYDMAN
JAKE GOLDNER
BOBBY GOODMAN
NICK HOUCHEMS
ELLIOT PESSIS
JON JAPHA, Capt.

JAZZ

BRIAN ANDALMAN, Capt.
REID BARTHA
TODD BLOCK
DAVID CHERNER
MATT WEISS
ADAM SCHREIER

SUPERSONICS

AARON EAGLE
JOE JACKSON
RICKY KIRSCH
GABE POLSKY
BRANDON SMITH
MATT PASSEN, Capt.

MCAA EARLY SEASON SPORTSHEET



Highlight Game:
LAZIO VERSUS ARSENOL

Score
ARSENOL 6 LAZIO 0

Goals
JAVIER BASAGOITI (penalty shot)
ANDREW DRAFT (5)

Comment:
An excellent game played by all the kids. This match certainly put the Intense into the Menominee Intense Soccer League!

Man of the Match - ANDREW DRAFT

Standings

Division 1	W	L
ARSENOL	2	1
LAZIO	1	2

Division 2	W	L
REAL MADRID	3	0
FC JERUSALEM	2	1
GLASGOW RANGERS	1	2
LIVERPOOL	0	3

Division 3	W	L
AC MILAN	2	0
SAMPDORIA	1	1
MANCHESTER UNITED	0	2



Highlight Game:
Brewers versus Indians

Score
Brewers 4 Indians 3

NOTABLES

Brewers
PETER BERNICK 2 RBI
DOUG LEVIN 2 IP, 0 ER

Indians
ELI PLATT 1 RBI

Comment:
This Central MLB game, the Brewers nipped the Tribe by a final score of 4-3. The Brewers scored first, taking a quick 2-0 lead, aided by PETER BERNICK's base hit. The Tribe came right back and tied it at two with ELI PLATT's base rap. BERNICK then put the Brewers on top to stay with another RBI single.

Standings

Eastern Division	W	L
Yankees	2	0
Orioles	0	2

Central Division	W	L
Brewers	1	0
Twins	1	0
Tigers	1	0
Royals	0	1
Indians	0	1
White Sox	0	1



Smythe Division	W	L	T
Winnipeg Jets	0	0	1
L.A. Kings	0	0	1

Scores:
Winnipeg 4
L.A. 4 F/OT

Norris Division	W	L	T
Detroit Redwings	1	0	0
Chicago Blackhawks	0	1	0

Scores:
Detroit 9
Chicago 3 F

Patrick Division	W	L	T
Pittsburgh Penguins	1	0	0
New Jersey Devils	1	1	0
New York Rangers	0	1	0

Scores:
N.J. 6
Pittsburgh 8

New York 5 F
New Jersey 7 F/OT



Highlight Game:
PISTONS VERSUS BUCKS

Score
PISTONS 35
BUCKS 31 F

STATS:
PISTONS
 JOEL SORINSKY 10 pts.
 ELI PLATT 1-2 3 pt. shots, 8 pts.

BUCKS
 RYAN HOLZ 21 pts.

RAPTORS VERSUS PACERS

Score
RAPTORS 60
PACERS 55

STATS:
RAPTORS
 DAN ROSEN 16 pts.
 SCOTT SCHAFF 18 pts.

PACERS
 PETER BERNICK 18 pts.
 JON FELDMAN 12 pts.



ANDREW DRAFT tries to elude the tenacious defense of JUSTIN HOROWITZ.

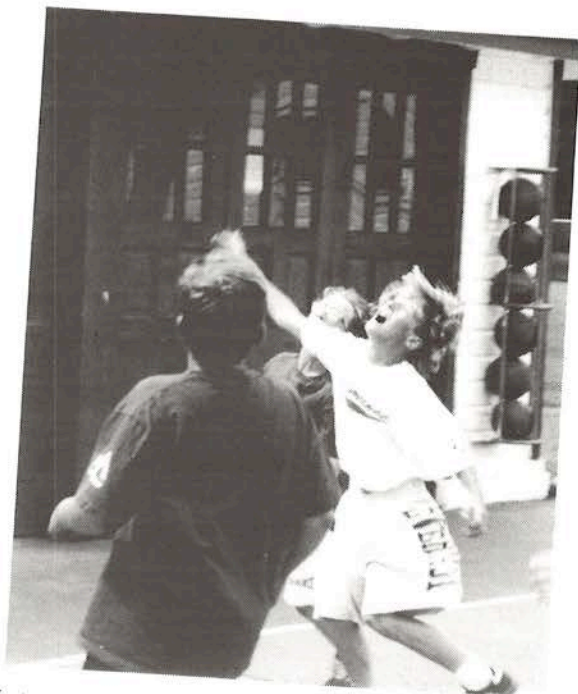

Intense action from the Knicks vs. Heat game. 16. J.D. McCORMICK boxes out for a rebound.

MEGAPHONE

SUNNY BUT WINDY FORECAST EDITION

JULY 18-20, 1994



"High Pressure" Takes Over Sun and Wind Moves In

BARRY QUAYLE and ARI ROSEN—

With the summer halfway over, it could only mean one thing: the start of Sun and Wind. This intra-camp competition divides the camp in half, counselors included, in many grueling events including: Capture the Flag, Creatively Acquire the Energy Source, Land and Water Events, and the ever popular British Bulldog. The captain for the Sun is ARI ROSEN, for the Wind, BARRY



QUAYLE. The two captains had the traditional fake brawl to get things underway and as team lists were tossed into the air by BOUTROS, the competition began.

The first event was the Pursuit Relay. In the relay, every member of each team must run around a set track and pursue the runner ahead of them. The team that finishes first, wins. This year, the Sun, led by Captain ARI ROSEN took the Relay.



BARRY QUAYLE and ARI ROSEN clash at the start of Sun & Wind.



The Wind gives their opening cheer to kick off Sun & Wind '94.



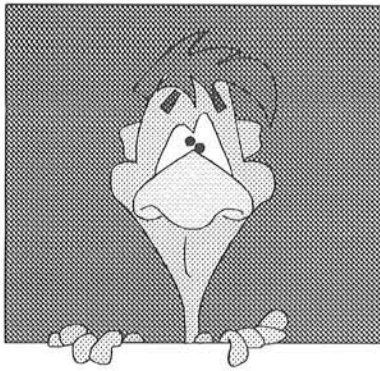

Sun Is Stupidest

BARRY QUAYLE—

The Sun and the Wind had a strange competition last night, "Stupid Human Tricks." Both teams had to come up with ten of the stupidest human tricks they could think of. Tricks ranged from PHILIP STERNHELL juggling with his eyelids turned inside out singing "Do You Hear the Voices Ring" to a knuckle cracking rhythm performed by JOSH ZEMEL and SCOTT SCHAFF. The Sun ended up winning by a unanimous vote.

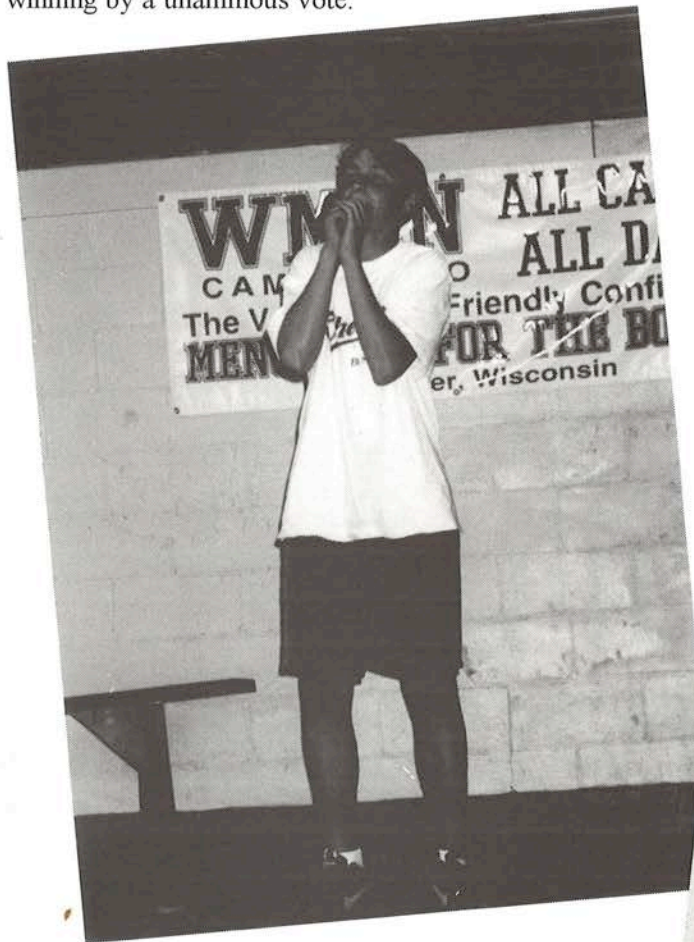

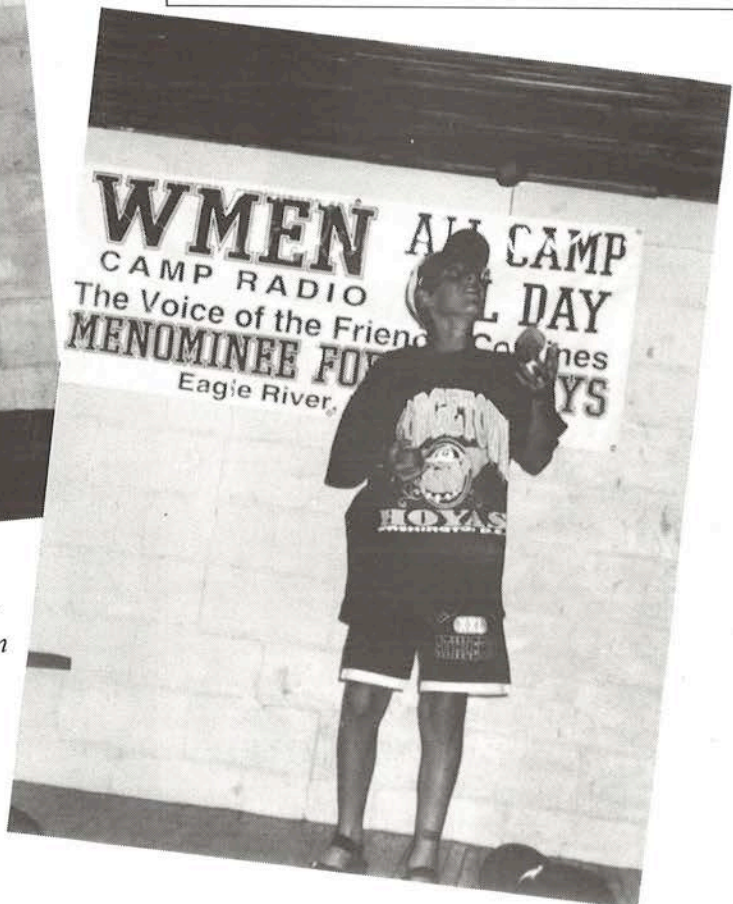

DANNY LEVY & CORY PROVUS give us their stupidest during the Sun & Wind Stupid Human Tricks competition.



U.N. Security Member JON KULESZA holds the Energy Source with care.

CREATIVELY ACQUIRE THE ENERGY SOURCE SCOREBOARD

	 Sun	 Wind
Game 1	7	21
Game 2	21	15
Game 3	18	2

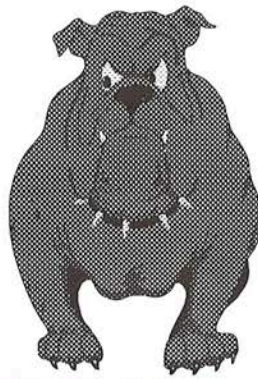

Wind Wins Without Wagging



ANDREW DRAFT—

It was a rainy day for the British Bulldog Sun and Wind competition. We played best 2 out of 3 to determine a winner. British Bulldog is played on a field with teams on opposite sidelines. At the start of the game, the two captains started in the middle of the field, and are called "bulldogs." Bulldogs are responsible for pulling other peoples tails (socks) out of the back of their pants

when they try to run from one end of the field to the other after their number is called. If one is caught by a bulldog, then they become a bulldog.

The highlight of the match was a major collision between the two captains as they were running across the field, trying to score. While neither captain made it, the Wind eventually won, two games to one.

Bullock Bedazzles Boys with Ball On Cup (Stick)



The wet weather conditions forced Menominee's annual Sun and Wind competitions into the packed and noisy Wasserman Hall for the 1994 Ball-in-the-Cup duel. The competition started slowly as both teams struggled to flip the small ball into the even smaller cup. As the match-up progressed the intensity grew. The Sun proved to be more up to the challenge than the Wind as they held an 8-1 advantage after every camper had had their turn. It was up to the counselors to determine the outcome, and what wound up happening was truly a story-book ending. Down to their last hope and

needing the next to impossible 25 point ball onto stick trick to win, the calm, cool, collected ANDY BULLOCK stepped up. As the sound hushed to a silence, BULLOCK steadied his hand and in one quick motion flipped the ball onto the tiny stick. And with it the Wind erupted into a deafening roar that was heard throughout the Northwoods, while the Sun stared in disbelief at what had just occurred. It was an ending that could not have been dreamed up any better, and with it a legend was created that will forever live in Menominee memories.



MIKE WEINER and DAVE SCHWARTZ and Captains BARRY QUAYLE and ARI ROSEN battle it out in the Rock, Paper, Scissors competition.

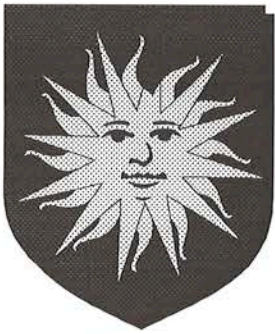

SUN

BARRY QUAYLE, Captain

TREVOR ABRAMSON
 BRAIN ANDROW
 JAVIER BASAGOITI
 PETER BERNICK
 BRAD BROOK
 DAVID CHERNER
 BRETT CHETEK
 SIM DARWICK
 DAVID DAVIDSON
 JEFF DAVIDSON
 BRANDON DAVIS
 CHRIS DICKEY
 DREW EDWARDS
 STUART EMMERMAN
 MANUEL ESCALANTE
 JONATHAN FELDMAN
 LEONARD FIALHO
 MATT FRANK
 JEREMY FRYDMAN
 JORDAN GOLDFARB
 BRETT GOLDNER
 MATTHEW GOODSTEIN
 ADAM GREENBERG
 MATTHEW GROSS
 EVAN HARRIS
 JOSHUA HELLER
 EVAN HERMAN
 JEFFREY HERTZ
 CASEY HINTZ
 MATTHEW HOLLANDER
 RYAN HOLZ
 ETHAN HOROWITZ
 JUSTIN HOROWITZ
 NICK HOUCHEMS
 JON JAPHA
 KEI KATO
 MATT KAUFMAN
 JOSEPH KLEIN
 ROB KOHEN
 JOSH KURZMAN
 JESSE LATORRE
 KEANAN LEVANT
 DOUG LEVIN
 BRANDON LEVY
 DAVID LEZAK
 ENRIQUE LONA
 HERBIE LUKES

MICHAEL MASON
 JEREMY MATIMORE
 PABLO MAYO
 JAKE MEILACH
 BRAD MENDEL
 LARRY MILLER
 BRAD MOSS
 JARED OLIAN
 MATT PASSEN
 ELLIOT PESSIS
 ELI PLATT
 CRAIG RASHKOW
 MICHAEL REICH
 SETH RHEINGRUBER
 DANIEL ROSEN
 JOE ROSENBAUM
 BRADLEY ROSS
 TED ROTH
 MATT ROTHSTEIN
 ANDY SCHIMEL
 DAVID SCHWARTZ
 ROSS SIDER
 BRANDON SMITH
 ERIC STANG
 STEPHEN STEIN
 PHILIP STERNHELL
 BRIAN SUMERS
 JARRET TURBIN
 JOSE VILLAVICENCIO
 COLIN WEINER
 ZACK WEINER
 ADAM WEINGARTEN
 MATTHEW WEISS
 BRIAN WHITE
 ALEX YUSPEH

Counselors

DEAN ANDREWS
 NATE AUSLANDER
 ERIK ECKBLAD
 ROBERT EMER
 DROR NAFTALY
 PAUL O'TOOLE
 NICK OLSON
 CORY PROVUS
 BEAR SCHWARTZ
 GAVIN SPOWAGE
 JASON WHITE
 BRYAN WHITFORD
 MARCUS ZAVOS



WIND

ARI ROSEN, Captain

BRIAN ANDALMAN
 ANDRES ARAIZA
 REID BARTHA
 JOSE BASAGOITI
 ANDREW BENDER
 JOSHUA BENJAMIN
 MATT BERCOVITZ
 TODD BLOCK
 TOM BUDASZ
 GEORGE BURDEN
 CHRISTOPHER CADY
 MATT COHEN
 RONJON DATTA
 JEFF J. DAVIDSON
 JAMES DICKEY
 ANDREW DRAFT
 JEFF DRITZ
 AARON EAGLE
 ROSS EDWARDS
 PETER EHRLICH
 JEREMY EMER
 MATT FINDER
 JORDAN GAULE
 JEREMY GLAZMAN
 JAKE GOLDNER
 STEPHEN GOLER
 BOBBY GOODMAN
 JORDAN GRANT
 JAY GUSTAFSON
 RENE HERTSBERG
 MICHAEL HERTZ
 MICHAEL HIRSCH
 JEFF HOOD
 JASON HORN
 PHILIPPE IFERGAN
 ERIC ISRAEL
 JOE JACKSON
 JOHN PATRICK JACOBS
 JUSTIN JACOBSON
 OREN JACOBSON
 ADAM KAPLAN
 SCOTT KAPLAN
 STEVEN KATZ
 HARRIS KEALEY
 RICKY KIRSCH
 JACOB KLEIN
 JUDAH KLEIN

MATTHEW KLEIN
 DAVID KRAUT
 JASON KUMMER
 DANNY LEVY
 ELLIOT LIEBERMAN
 JUSTIN MATIMORE
 J.D. McCORMICK
 JAMES McGOVERN
 JOSH MERSFELDER
 MIKE MESIROW
 JAKE NEIMAN
 ENRIQUE OJEDA
 AARON PERNA
 BRETT PESSIS
 GABE POLSKY
 JARED RALSKY
 BRETT RHEINGRUBER
 TODD RHEINGRUBER
 EVAN ROSENBERG
 HARLEY ROSENTHAL
 JORDAN ROTHSTEIN
 SCOTT SCHAFF
 JOHNNY SCHATZ
 ADAM SCHREIER
 BARRY SCHWARTZ
 MATTHEW SCHWARTZ
 TODD SCHWARTZ
 JON SIEGEL
 BRYAN SIMKIN
 ANDY SLUSSER
 MICHAEL SOLOVY
 JOEL SORINSKY
 JEFFREY STEIN
 COLIN TAHI
 NICHOLAS TALBOT
 BRIAN TEPPS
 MICHAEL WEINER

Counselors

GREG ABRAMS
 ROSS AUSLANDER
 DOOGIE BELCHER, M.D.
 ANDY BULLOCK
 MIKE BURLING
 BERNIE CUNNINGHAM
 FRANK JOHNSON
 ANDREW PINGER
 JOSH ROTHENBERG
 CARL ROWLAND
 JOPLIN SELL
 ALAN TRUBOW
 MAV WALTON

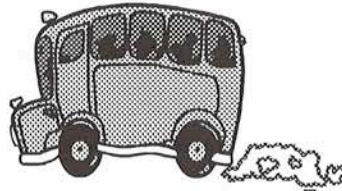

[Chippy Show & Social] A Blast

HERBIE LUKES—

As has become a tradition these days, C.M. traveled to Chippewa Ranch Camp to see their visiting day show. The whole camp packed into the Chippewa Barn to see a variety show which included several song and dance acts as well as many familiar commercial imitations. The program was enjoyed by the entire audience. After the performance,

TOM ADLER, the owner of Chippewa, invited C.M. to have a late-night snack in their mess hall consisting of brownies and fruit punch which were great! During the social, the guys from C.M. had an opportunity to talk with old friends at Chippewa and meet some new ones. It was a blast! Hopefully, we will do it again soon.

SCHAFF'S PRESSURE FREE-THROW LEADS TO CM VICTORY



"H" goes over some rules before the start of the Ray Meyer Games.

"H"—

Play Hard! That was the battle cry for the 11 and under basketball team that went to Ray Meyers' Basketball Camp. The taller stronger team from the Coach's camp was very cocky at the opening tip. CM kept the game close as MATT KLEIN ran the point. DOUG LEVIN and ELI PLATT controlled the boards. Also up front was BRETT RHEINGRUBER and JARRET TURBIN. The defensive attack and intensity was led by outstanding defenders, MICHAEL WEINER, DANIEL ROSEN, and JUSTIN "Spud" HOROWITZ. Off the bench with a strong surge were: MARTY WEISMAN, JAY GUSTAFSON, and JOSH ZEMEL. Leading the way on "O & D" was SCOTTY SCHAFF. As the game wound down, CM stayed within four points the whole fourth quarter. Then SCOTT SCHAFF came up with a great garbage hoop. We were able to stop Ray's Camp again. Then CM was patient with 45 seconds remaining. Finally, the ball wound up in ELI PLATT's hands five feet from the hoop and he hit nothing but the bottom of the net. Then we pressed, got the steal, and SCOTTY SCHAFF was fouled with 1 second remaining and a tied score. We were in the bonus, and SCOTT hit the first one, missed the second one, and because of our tough D. Ray Meyers Camp couldn't score. Final Score 24-23 CM!

13 HOOPS TAKES IT ON THE CHIN AT RM

BRIAN ANDALMAN—

It was beautiful Wednesday as Menominee traveled to Ray Meyer Basketball Camp for a Hoops competition. Menominee sent over three teams. An 11, 13, and 16 and under teams were all there. It would end up being a very long day for the 16 and under and 13 and under teams.

The 13 and under game started off pretty evenly with starters JON JAPHA, LARRY MILLER, COLIN TAHI, CRAIG RASHKOW, and BRIAN ANDALMAN doing a fine job. Ray Meyer's team, though, broke out in the beginning of the second quarter, but thanks to LARRY MILLER, Menominee came back and was only down by five points at half-time.

The second half would not be to promising. Ray Meyer's team ran away with the game. Menominee ended up losing by 22 points; the score was 56-34. Many of the subs helped Menominee too. They were TODD RHEINGRUBER, JOHNNY SCHATZ, TEDDY ROTH, SETH RHEINGRUBER, OREN JACOBSON, ALEX YUSPEH, and TOM BUDASZ.

Menominee showed great effort and sportsmanship throughout the whole game.



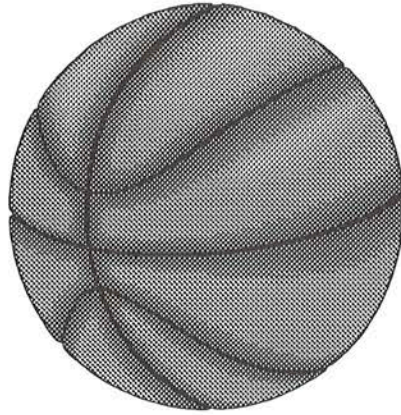

16A B-BALL TRAVELS TO RAY MEYER'S

BARRY QUAYLE—

The Menominee 16A basketball team took on Ray Meyer's team. Ray Meyer started off very strong. We had trouble bringing the ball up. Menominee never gave up and we had a run late in the first half led by MATT PASSEN. We also saw great playing from ANDY SCHIMEL, GABE POLSKY, AARON EAGLE, JEREMY FRYDMAN, and

MATT WEISS. Our guys never gave up even though Ray Meyer was beating us the whole game. The second half was much better for Menominee. MATT PASSEN led us with a three pointer followed by JEREMY FRYDMAN. Although we lost by a large margin, we will be ready for another game against them next year.

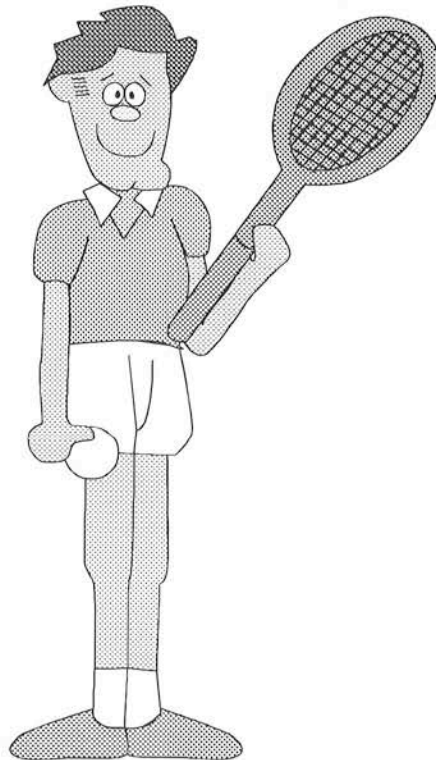

Tennis vs Kawaga Revisited

ANDY ZLOTNIK—

After a years break from competition with Kawaga, we hit the courts for a hard nosed tennis battle. The team was headed by JEFF DAVIDSON at number one singles. Unfortunately, he was unable to produce a victory, but he was still able to help the team with his enthusiasm and great

attitude. GABE POLSKY, however, crushed his opponent and gave Menominee a mark in the win column. Great performances were given by PHIL STERNHELL, EVAN ROSENBERG, and MATT PASSEN as well as the rest of the Menominee squad.

MEGAPHONE

CM vs DH EDITION

JULY 21-22, 1994



Huge Hardball Win For C.M.

FRANK JOHNSON—

The beginning of two days of competition against Deerhorn began with a 16 and under hardball game last night. Camp Menominee took advantage of four walks issued by Deerhorn pitching, an RBI single by MATT "Softball Is For Girls" ROTHSTEIN, and a fielder's choice by TODD SCHWARTZ to gain a quick 3-1 lead after one inning of play. BRIAN ANDALMAN pitched the first three innings for C.M. Menominee exploded for five runs in the fourth inning to take an 8-4 lead. Once again five walks by Deerhorn pitching helped the cause. Other highlights in the inning were an RBI ground out

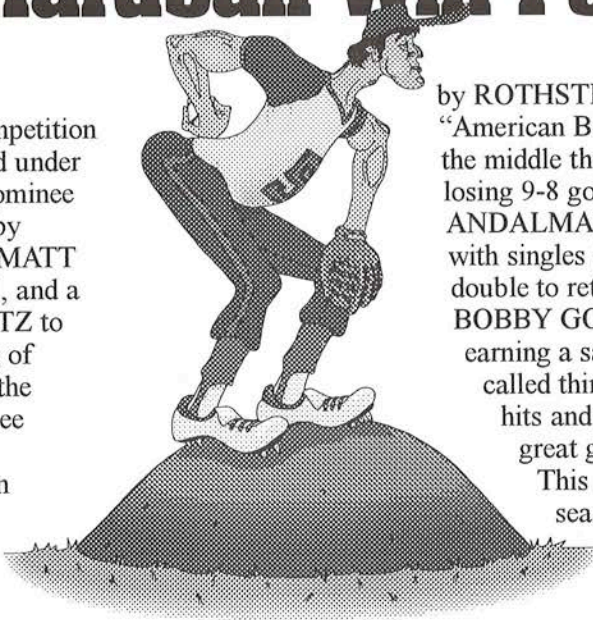

by ROTHSTEIN and an RBI walk by AARON "American Bald" EAGLE. COLIN TAHI pitched the middle three innings and C.M. found itself losing 9-8 going into the bottom of the sixth. ANDALMAN and JEREMY FRYDMAN led off with singles then SCHWARTZ hit a two RBI double to retake the lead for Menominee, 10-9. BOBBY GOODMAN pitched the final inning, earning a save, and getting the final out on a called third strike. MATT COHEN had two hits and PHILIPPE IFERGAN made four great grabs in right field.

This was yet another day in a great season for Menominee Hardball in '94.

HERTSBERG AND BENDER PROVE SOCCER MVP'S VS. DEERHORN

ALAN TRUBOW—

On Thursday, Menominee took on Camp Deerhorn in 13 and under soccer. The team made a valiant effort, but in the end the team from Deerhorn prevailed by a score of 4-3. The team was lead by ANDRES ARAIZA in the goal who made many amazing saves. STEPHEN STEIN, ADAM KAPLAN, and MIKE SOLOVY also played well, aggressively attacking the ball. In the front, the team was led by MATT KAUFMAN, PETER BERNICK, and PETER EHRLICH who put shots on Deerhorn's goal the entire game. The big surprises of the game were ANDREW BENDER and RENE HERTSBERG who played outstanding games and they both were definitely MVP's of the game. All in all, a great game was played and the whole

team gave 100%, and the game was played the Menominee way.

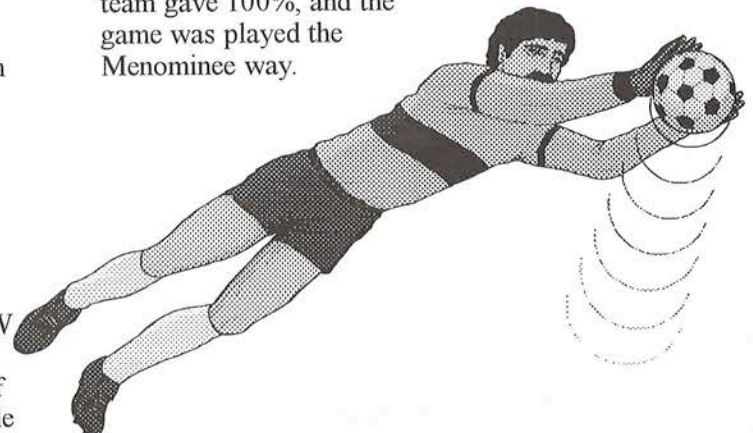

MENOMINEE

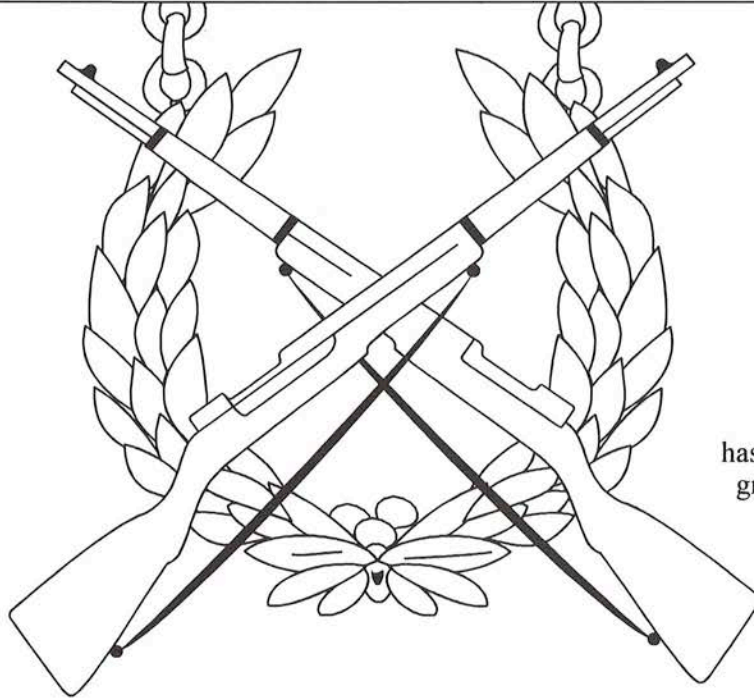

C.M. Comes Up a Dozen Short vs. DH

BRETT GOLDMAN—

As the sun set in the west, the 16 and under riflery team assumed the firing position. They were rugged and frosty, but ready for a challenge. BRANDON SMITH led off with a 60 matched to a 37 by the Deerhorn shooter. The early results favored a Menominee win. BARRY SCHWARTZ stepped up with a 64 to Deerhorn's 66. Tough DAVE LEZAK came in with the team high 65 to the other's 59. But just as JEREMY FRYDMAN came in to shoot, the comet that was striking Jupiter aligned with the moon blotting out the sun. In the darkness, Deerhorn's infrared scopes provided the edge they needed. Even in pitch black JEREMY scored a 24. But, Deerhorn came up with a 63. With the help of a natural phenomenon Deerhorn walked away with the 12 point victory, 225-213.

Young Shooters Score BIG

BRETT GOLDMAN—

In the annals of history, the Menominee riflery team

has been associated with greatness. Consistency is a virtue and tradition, a, well, it's a tradition. Coach BOUTROS "Waco Kid" GOLDMAN put together a team of youthful talent. The juniors are poised for a future of greatness. ERIC ISRAEL shot

a 49. JEREMY MATIMORE pumped in a 64, MIKE "Lottery Money Makes Me" REICH scored 44, and BRAD ROSS, a junior, wide-eyed, innocent, youthful boy, put up a competition high 74 points. When all the lead had cooled and the last shell lay smoking on the ground, the score totaled 231-200 in favor of Menominee. Yee Ha!

Menominee Dead-Eyes Deerhorn

DROR NAFTALY—

It was a clear and sunny morning in a camp far away called Camp Deerhorn. The riflery competition was set up as not only a competition between riflemen, but to see overall which camp was best. The first shooter from Menominee was SIM DARWICK, who beat his opponent from Deerhorn 63-60 and gave Menominee the first edge. Then Deerhorn came back after the second shooter and took a 12 point lead. JEFF HERTZ was the third shooter and narrowed the lead to a mere five points. Then came BRETT GOLDNER, the final shooter, to try to put Menominee over the top for victory, and he did just that. Menominee won the shoot-out by a slim margin of four points. After a loud Alvevo, the team that remained standing was Menominee.

JAKE GOLDNER is poised to take first in the individual Backstroke.

10 Stokers Swim Strong

CARL "Rawhide" ROWLAND—

Sand Lake was the setting for the close ten and under swim meet. The team selected through rounds of qualifications and time trials were ready to take on the boys from the camp called Deerhorn. The Medley Relay was the first event which included ROB KOHEN, MATT SCHWARTZ, ANDREW DRAFT, and JOSH HELLER. KOHEN started it off with the backstroke and quickly took the lead. Next was DRAFT, then on to SCHWARTZ, followed by HELLER. A fighting performance that nearly won it, but Deerhorn was just a little faster.

Next up was the Freestyle individual competition with HARRIS KEALEY and BRAD ROSS. The amazing swim by KEALEY and ROSS brought victory to Menominee. The Breaststroke was next with JEREMY EMER and ERIC "Piano Man" STANG swimming for Menominee. Menominee finished second and third. C.M. had MIKE REICH and ERIC ISRAEL in the individual Backstroke, but they came up just short. KEALEY soon pulled the score of the meet closer with an outstanding Butterfly time to take first place. So, it all came down to the Freestyle Relay. BRAD ROSS started fast and passed to BRANDON DAVIS who swam well. ANDREW DRAFT swam the third leg and tagged the dock to start the anchor man, KEALEY. Everyone game 100%, in the end however, Deerhorn just piped us to the win. It was a great swim meet enjoyed by everyone.

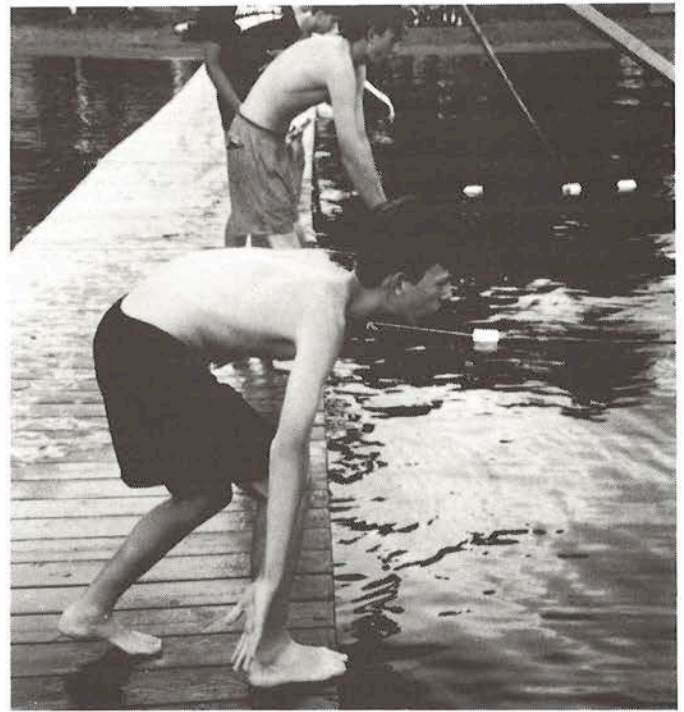

Swim Meet Brings Excitement

JEFF HOOD—

Friday morning was the setting for one of the most exciting swimming events in C.M. history. All of the Menominee swimmers were ready for the tough challenge brought upon them by the fierce competitors of Camp Deerhorn. The first event of the meet was the Medley Relay which was won by Menominee. The next event was the Freestyle and JEFF HOOD took first place. Then came the Butterfly and Breast strokes, the two toughest for Menominee, and they were both won by Deerhorn swimmers. JAKE GOLDNER took first in the last individual event, the Backstroke. Finally came the last event of the entire meet, the Freestyle Relay. Menominee led by two points going into this event, so the outcome of the relay would determine the winner of the meet. "Shoeless" JOE JACKSON started off giving Menominee a strong lead, but the lead was soon erased.

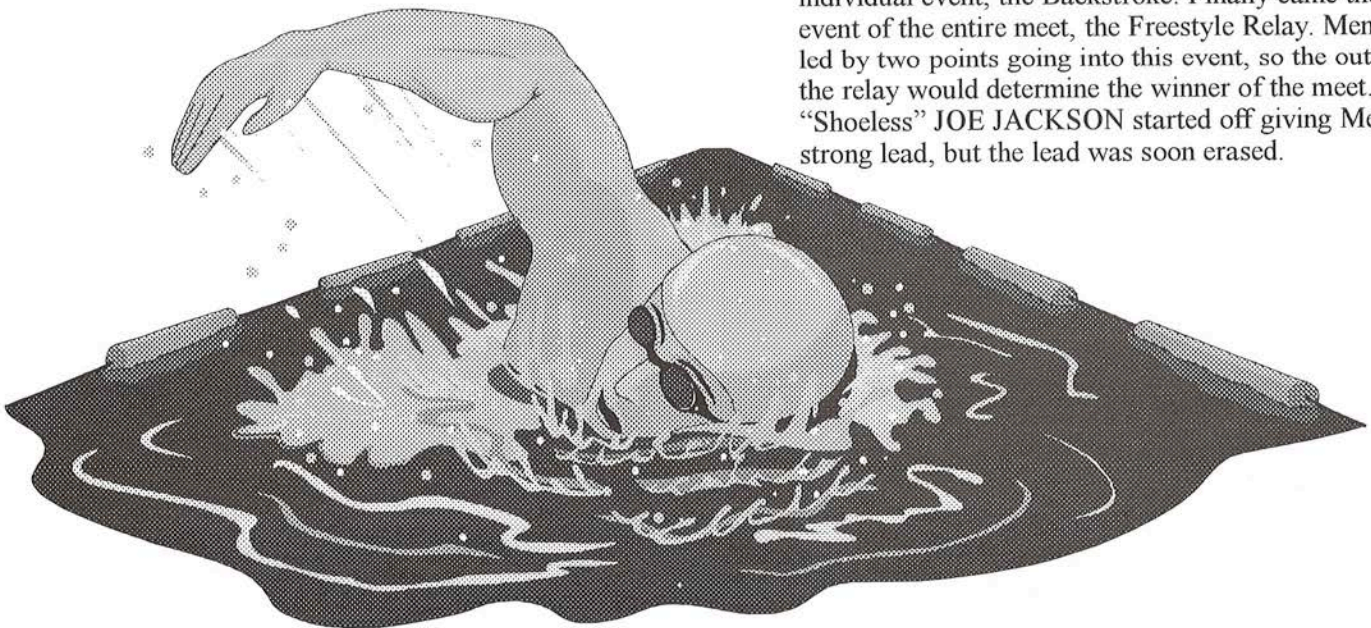

“WMEN” Means Win Menominee For Tennis

ANDY ZLOTNIK—

Friday, the Menominee tennis team headed to Rhinelander to play against Deerhorn. The 13 and under squad was ready to do battle on the courts. The team was headed by MIKE WEINER at number one singles. After starting down 2-0, MIKE came back and challenged his opponent. In the end, MIKE overcame the deficit and broke down his opponent to win 6-3. JARED RALSKY played number 3 singles in his first match of the year and easily did away with his foe 6-2. PETER EHRLICH and BRETT CHETEK, who had played tough all season long, once again overpowered the opposing Deerhorn doubles team. Consistent with the other outings by the 13 and under squad, Menominee came home with the “W”.

*SAM YUSPEH
prepares to smash a
forehand in his match
vs. Deerhorn.*



Seniors Serve Up Tennis Comp

TONE—

It was a beautiful day at the Friendly Confines as C.M.'s 16 and under tennis team took on Deerhorn. With two talented teams it promised to be an exciting afternoon. In the singles, MATT ROTHSTEIN played very well to win 6-3 while GABE POLSKY had to turn his match around in an uphill battle to come out on top. Going into the doubles matches, the meet was tied at two, with three matches yet remaining. ADAM SCHREIER and BRANDON SMITH went down to the wire, losing just barely. 3-2 Deerhorn. MATT PASSEN and PHIL STERNHELL tied it up 3-3. In the final match, a good #3 doubles team from Deerhorn won and the meet went to Deerhorn, 4-3. It was a good afternoon, played enthusiastically and with high spirits.

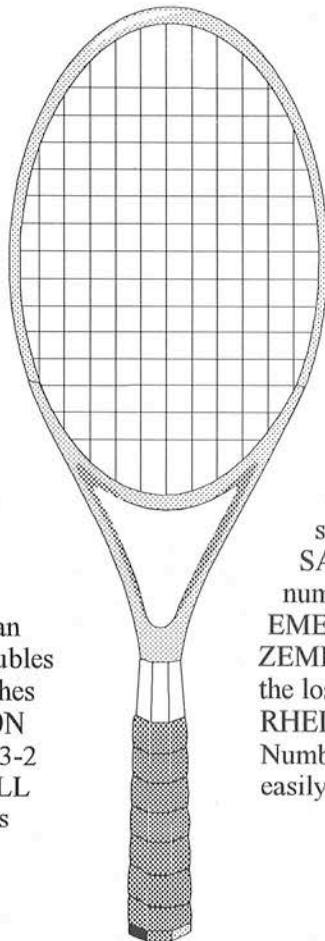

Ten & Under Tennis Nipped

TONE—

C.M.'s ten and under tennis team took to the courts at the Friendly Confines against a strong Deerhorn team. Number one singles, SAM YUSPEH, lost in a very close match, while numbers two, three, and four singles, JEREMY EMER, JUSTIN “Spud” HOROWITZ, and JOSH ZEMEL, respectively played hard but came out on the losing side. In the doubles matches, BRETT RHEINGRUBER and SCOTT SCHAFF won 6-1. Number two and number three doubles both won easily which brought Menominee close.

12 HOOPS WIN BY 12

EVAN HARRIS—

The twelve and under Basketball game at Deerhorn was a great one. Menominee started off slow. Deerhorn scored the first couple of points and it looked like Menominee would be beat, but we stepped up. JOEL SORINSKY, RYAN HOLZ, EVAN HARRIS, ETHAN HOROWITZ, and JORDAN GRANT led the comeback. Within a few minutes, Menominee was in control. JOEL SORINSKY and RYAN HOLZ

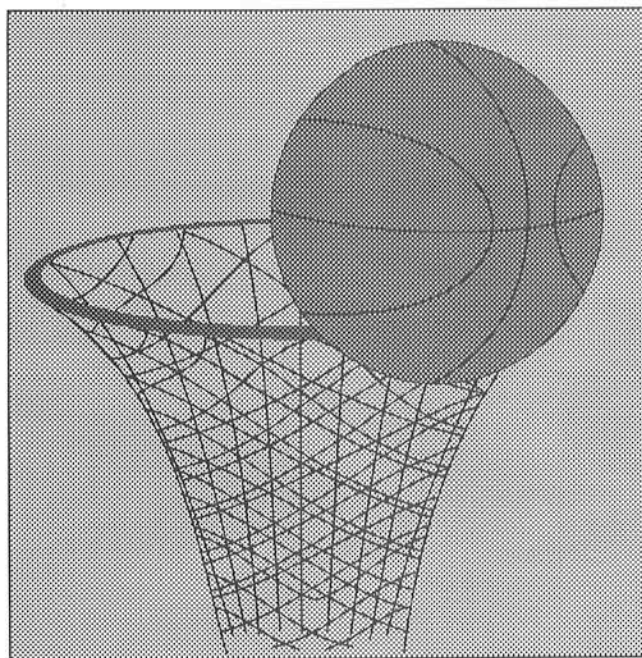

had some big baskets down the stretch. In the fourth quarter, defense held Deerhorn back. ETHAN HOROWITZ was all over every loose ball. JORDAN GRANT came up with some huge steals and EVAN HARRIS blocked two shots. Menominee won by 12. Providing solid play and great hustle off the bench were: JORDAN GAULE, ANDREW BENDER, DANNY LEVY, PETER EHRLICH, and MATT FINDER. It was a great win for Menominee hoops.

16 HOOPS VS. DEERHORN

*HARLEY ROSENTHAL and
TREVOR ABRAMSON—*

On Friday, we had a big competition with Camp Deerhorn. At about 2:30 in the afternoon, the 16 and under basketball team took the floor. The first few minutes were very average for both teams. As the game passed on, it seemed Menominee was getting beat more and more.

Our coach BARRY QUAYLE was trying to think of different strategies for the team. One of the reasons we were getting beat so badly was because of their height. Each and every single player was at least six feet tall. They were not that great, but they got every single rebound. Even if four of us boxed out, they still managed to get the rebound somehow.

At the end of the game, in the words of JOE ROSENBAUM, a cabinmate and teammate, "It was a hard battle fought well."



LARRY MILLER boxes out for a rebound in the 16 and under hoops game vs. Deerhorn.

INTENSE HOOPERS FALL FIVE SHORT

JON "Coach-A-Cola" KULESZA—

With an enormous team and great enthusiasm, Menominee's 10 and under basketball team came out playing tough defense and fast paced basketball. Unfortunately, after one quarter, we were down six baskets. We came out smokin' in the second quarter, led by JUSTIN "Spud" HOROWITZ and SAM "The Man" YUSPEH.

"Spud" HOROWITZ finished with four points in the quarter and SAM wound up with five. In addition, ANDREW DRAFT and MICHAEL REICH sparked the offense with four points each. The game finished with a flurry of shots by Menominee, however we fell short by five points with a final score of 32-27.



SOCCER SHOOT-OUT STILL SOMETHING SPECIAL

JUSTIN HOROWITZ—

It was an exciting 10 and under soccer game against Camp Deerhorn. Deerhorn struck early with a goal against BRETT RHEINGRUBER. Deerhorn scored again shortly after because of a defensive mix-up by Menominee. Deerhorn went on to score two more tough goals that even BRETT could not stop. In the end of the first half the score was 4-0 Deerhorn. Menominee was up against a great challenge.

In the second half, it was scoreless for about seven minutes until Deerhorn scored a goal on replacement goalie JORDAN ROTHSTEIN. Later on that half, Menominee got their first shot of the game.

The game ended with Deerhorn on top 5-0. Menominee played well, but Deerhorn was tougher in the end.

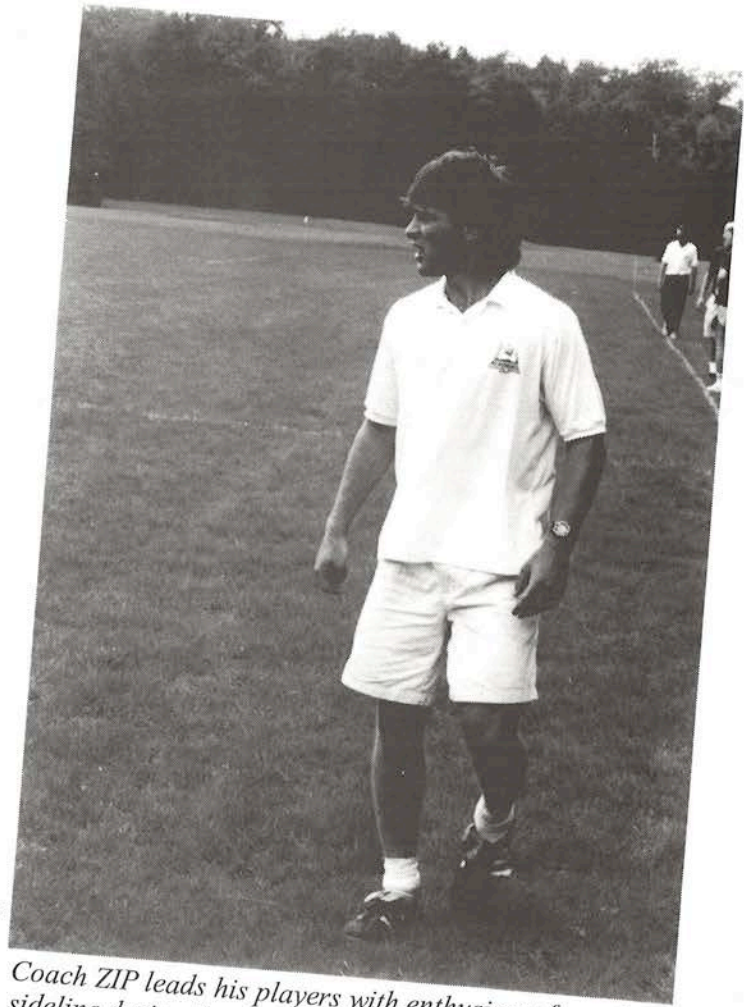

Coach ZIP leads his players with enthusiasm from the sideline during the 10 and under soccer match vs. Deerhorn.

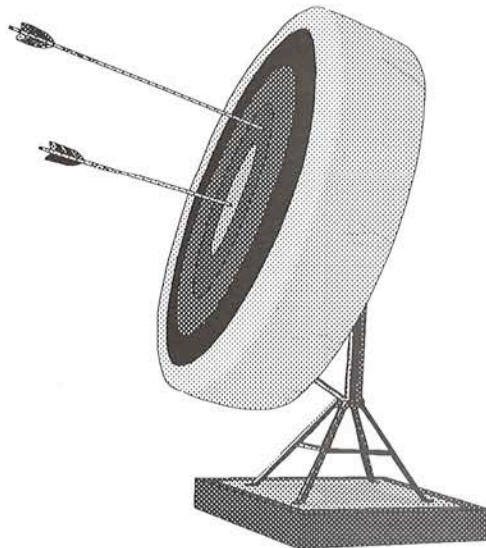

EAGLES ON THE MARK VS. DEERHORN

BERNIE CUNNINGHAM—

WHO ARE WE? C.M.! This was the battle cry of Menominee's 10 and under archery team in their competition against Deerhorn. Our team was domineering, with the likes of HARRIS KEALEY, BRANDON DAVIS, JOSH HELLER, and JAMES McGOVERN. All our boys

gave it their best and came up with final scores of: 74, 70, 82, and 88 versus Deerhorn's totals of 62, 47, 78, and 70. The overall score showed C.M. dominance in archery with 314 compared to Deerhorn's valiant effort of 257. Once again, the Soaring Eagles gracefully flew over the Deer's who were left out to pasture.

EM SIGHTS SET HIGH - THEN SATISFIED

BERNIE "Trust Me, I'm From Australia" CUNNINGHAM—

The event started off in controversy. First, Deerhorn's shooters did not have sights on their bows, so they thought we should remove our sights - "NOT". HERBIE LUKES started off our onslaught on Deerhorn with a solid two rounds of 44 and 42, beating his Deerhorn competitor by only 2 points. EVAN ROSENBERG followed LUKES with

a 44 and 48, squashing his opponent who shot a 36, 32. At the half way mark, our boys had the Deer by the Horn and could taste victory. BRYAN SIMKIN came home strong with a casual 50, 46 to top their best at 42, 46. AARON EAGLE brought the win home with a 42, 44, to seal the fate of the Deer's final chance who only managed a 34, 42. Final score of the meet: Menominee 360, Deerhorn 316.

SOARING EAGLE ARCHERS' FEATHERS NOT RUFFLED

GAVIN SPOWAGE—

The Menominee 13 and under archery squad of COLIN WEINER, MATT HOLLANDER, JEREMY GLAZMAN, and anchorman DANNY LEVY triumphed over a very capable Deerhorn team on Friday. With GAVIN SPOWAGE making his debut as coach, nobody knew what to expect from this match-up. Menominee was at a disadvantage even before the first arrow was fired as Deerhorn requested the competition be undertaken from twenty yards rather than the usual fifteen.

But nothing could ruffle the feathers of the cool, calm, and collected Soaring Eagle COLIN WEINER. He stepped up to the mark and promptly rattled in two stunning rounds of 42. The score after the first round was 84-70 Menominee. MATT HOLLANDER contributed with a total of 49. After the second round it was Deerhorn ahead 140-133. JEREMY GLAZMAN worked hard to record a 68 and take the meet to a climax. The score was 201-198 and it all came down to DANNY LEVY to show his class. His score of 72 meant that it all came down to the final arrow. The Deerhorn anchorman needed to shoot in the red to give them the seven points they needed for victory. He could only manage three points and Menominee recorded a famous victory. A fitting end to a great contest.



MEGAPHONE

SIGNATURE EDITION

JULY 23, 1994



Camper s Leave

This Friday, provided a perfect day to have the members of CM, '94 enshrine their place forever in Menominee history by

Their Mark

signing "The Cement." This year's cement was laid on the west side of the new sports rink and it marks the first time since

At Cement '94

1987 that a new location for cement was used.



BRETT "Boutros" GOLDMAN videotapes the finished cement.



Along with so many other improvements made at C.M. this year, the rock pathways that surround the Near Basketball Court and Sports rink were created by GENE FLECK. He is being assisted by MARC BEERMANN, as CORY PROVUS looks on.

Soaring Eagle Jerseys Well Hung

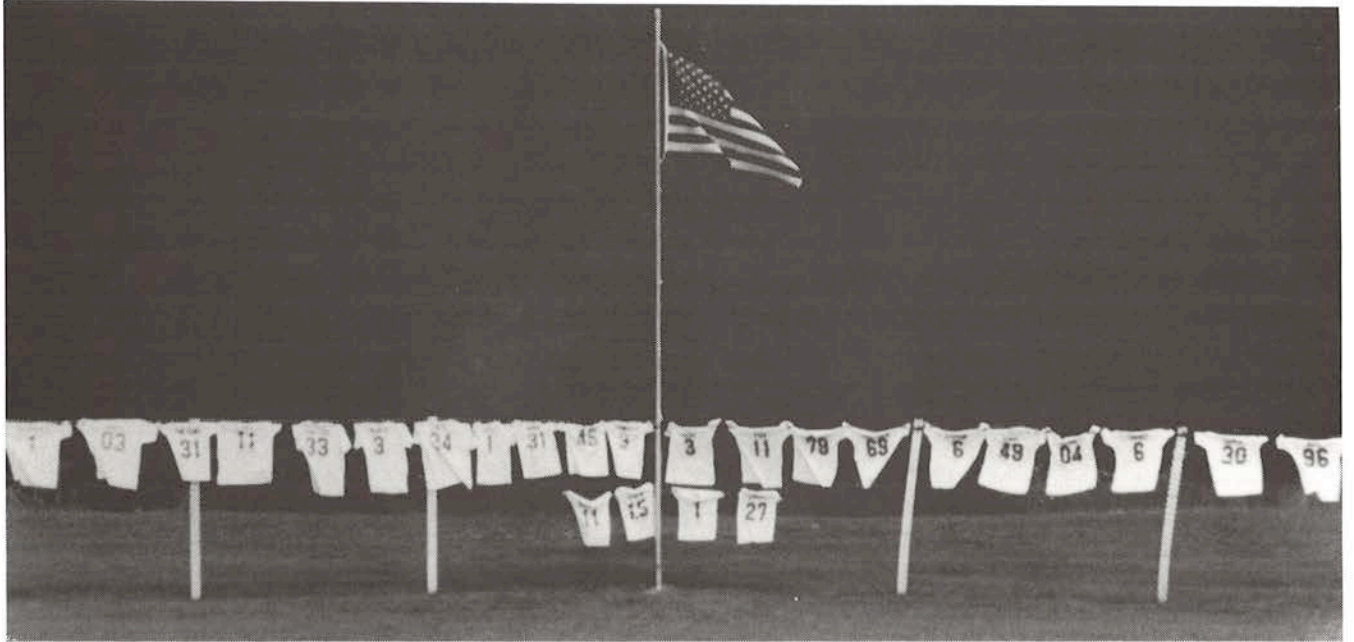

Jerseys hung around the center field flagpole on new Al Lewis.

As the day before the second OJ competition passed, the camp's intensity level was steadily nearing its peak. However, a spark was needed to push it to the limit. This spark was provided by the unveiling of the 1994

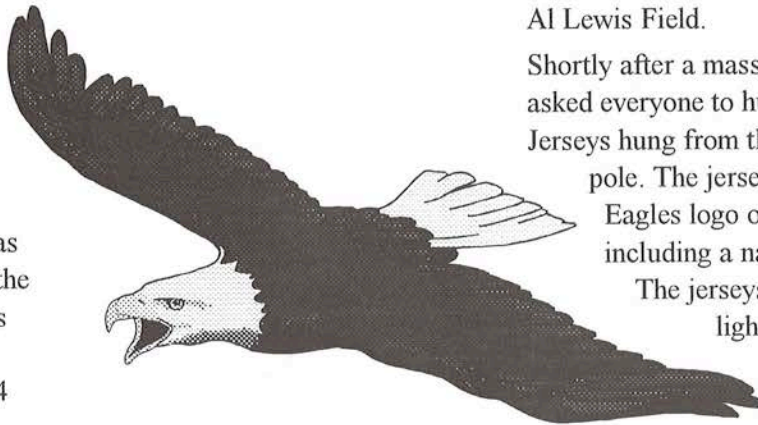

Camp Menominee Soaring Eagles Team Jerseys out on new Al Lewis Field.

Shortly after a massive pep rally during lunch, GLENN asked everyone to hustle out to Al Lewis Field where the jerseys hung from the outfield fence from foul pole to foul pole. The jerseys have the official Menominee Soaring Eagles logo on the front with a customized back including a name and number.

The jerseys were hung in the cabins, not to see the light of day until the first round of events the next day.



JUSTIN HOROWITZ emerges from the tunnel to get his jersey.



ALAN TRUBOW pumps up JORDAN GAULE, OREN JACOBSON and JEREMY GLAZMAN for "The Wave" during the Jersey Ceremony.

CM Skiers Do The Job

MARCUS
ZAVOS—

Our ski team arrived at Kawaga early on Friday morning. The sun was already shining hard, promising us a good day. Our team consisted of four of camps' older members: EVAN ROSENBERG, GABE POLSKY, JEFF DAVIDSON, and PHIL STERNHELL.



GABE POLSKY gives a "thumbs up" to the Menominee Ski Team's performance at the Kawaga Ski Competition.

Three other camps were competing including Red Arrow,

Timberlane, and, of course, Kawaga. Skiers were tested in three disciplines: slalom, trick skiing, and barefooting.

First up was slalom, which all four of our spirited team competed in. Considering our lack of relative experience, we performed very well. JEFF DAVIDSON scored four and a half buoys at 26 miles per hour, while the other three came close to this mark. Our outstanding consistency gave

our team second place overall.

Second up was the trick ski competition. GABE POLSKY had two great 20 second run's, using a combination of side slides and wake 360's. We narrowly missed third place out of a total of six competitors.

Finally, at about three p.m., we started the barefoot event which was to be judged on tricks and distance, if necessary, to decide a tie. PHIL STERNHELL began with a very impressive deep

water start with several wake crosses to notch up his score to first place. His first place was short lived as our own GABE POLSKY forced him into second by his one foot routine. Thus, we attained first and second place in barefooting.

It can be said that the Menominee team performed extremely well and in the face of very strong competition, came out on top.

PEP TALK PAYS DIVIDENDS

MIKE SOLOVY—

It was Wednesday afternoon as the Menominee 13 and under soccer team took the field. At the beginning of the game the Menominee team started slowly, giving the St. Germain All-Stars a 6-0 lead going into the second half. A great talk from coaches WOODY and ZIP at half gave the team the extra notch of enthusiasm they needed. About halfway through the second half we had a break away. BRETT CHETEK took the ball and passed in front of the St. Germain goal to JOHNNY SCHATZ who dribbled, shot, and scored. The Menominee bench went wild, the effort by the Menominee soccer team was phenomenal in the second half. Even though we lost 7-1, everyone was still happy they got to play. PHILIPPE IFERGAN played an excellent game in goal.

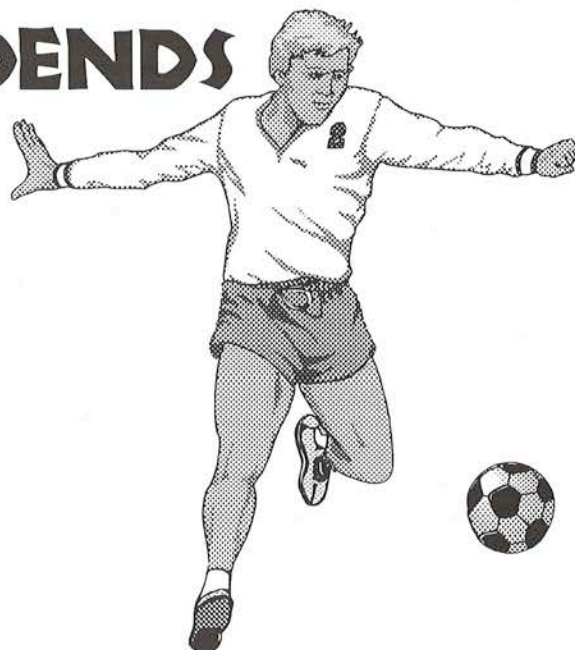

MEGA PHOTO MONTAGE:

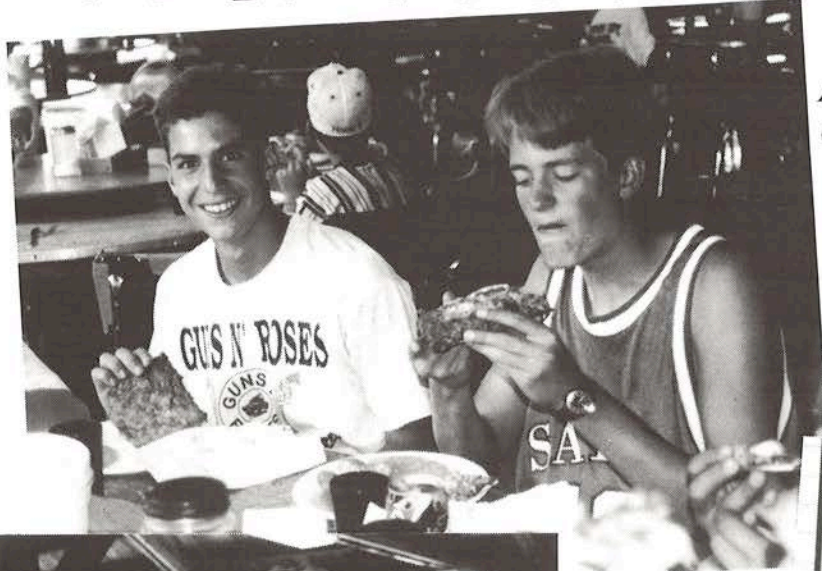

ANDY SCHIMEL and JEFF HOOD
chow down on lunchtime pizza.

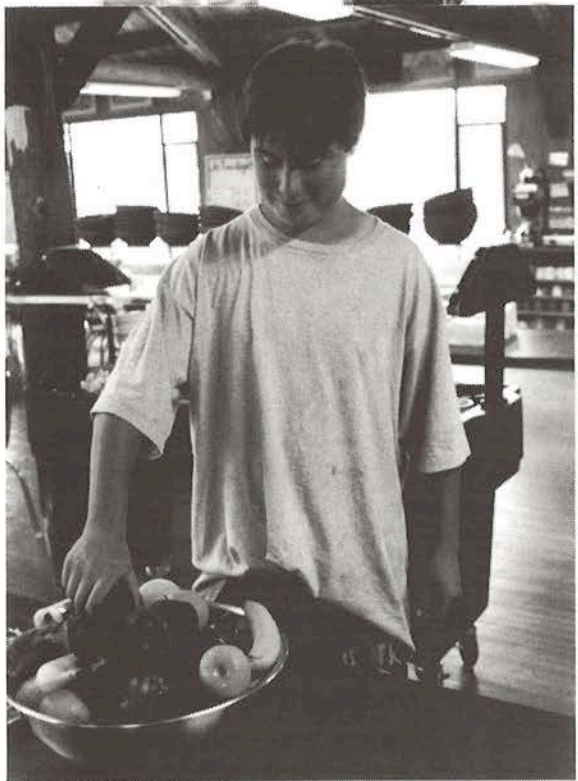

ARI
ROSEN
picks a red
delicious
from the
fruit bowl
in the mess
hall.



JOE ROSENBAUM enjoys a
coke with LEONARD "King For
A Day" FIALHO and RYAN
HOLZ.



ROB EMERY
crosses his fingers in
hopes that his free-
throw will fall in a
game of Lightning.

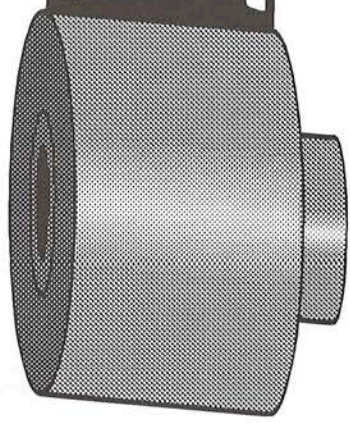

MEGAPHONE

ROUND TWO EDITION

JULY 24, 1994



Menominee Takes It To Ojibwa

After getting our jerseys yesterday, we were psyched to take on Ojibwa for a second time. This time, the 11 and 16 and under age divisions travelled to the other side of Eagle River while the 13 and under age division stayed at the Friendly Confines.

Some exciting events took place early afternoon, including 13 and under tennis and 11C softball, Menominee geared up for a series of basketball games. Menominee's intensity and overall great attitude put them over the top in many events. The incredible effort by the camp was rewarded by a pizza party that night courtesy of GLENN and DAWN.

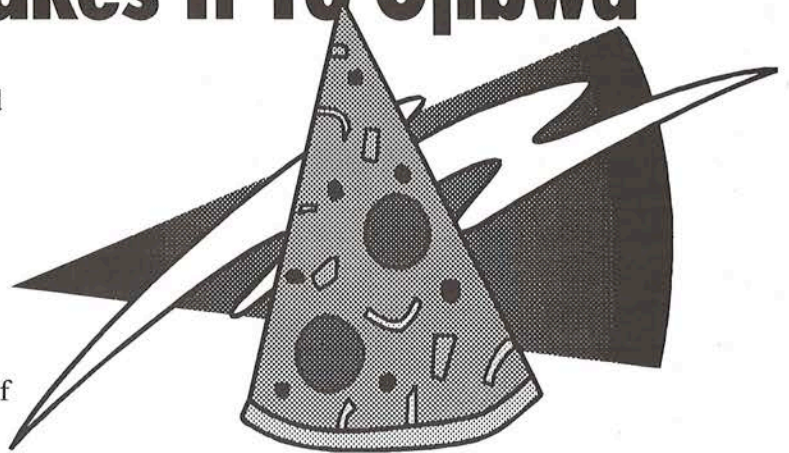

JUNIOR BOWS SHOW C.M. DOMINANCE

BERANRD CUNNINGHAM—

The archery range is definitely Menominee's place. Our 11 and under team, although faced with a lot of disturbances, held their ground and then moved on to victory. BRANDON DAVIS shot a 30, 38 for a good lead. ERIC ISRAEL excelled in shooting a 44, 46. JOSH HELLER also shot a 44, 46. BRETT (SCOOTER) GOLDNER lead the first half of the team with 38, 42, and JAMES McGOVERN steadily shot a 50, 50 as well. COLIN WEINER shot a 52, 48.

Our total scored of 528 to OJ's score of 472 echoed our dominance of archery across the land.

SENIORS SHOOT STRAIGHT

ANDREW PINGER—

Menominee is soaring high at all the archery events against OJ. The 16 and under team rocked as STEW AUSLANDER put in a frightening score of 54, 52.

BOBBY GOODMAN shot a reliable 28, 28 and JEREMY FRYDMAN did his work and came home with 32, 36. LEONARD FIALHO put in his bit with 44, 40. A 37, 44 to AARON EAGLE and 46, 46 to RICKY KIRSCH finished off our day with a total of 487. OJ total score of 462 wasn't quite strong enough.

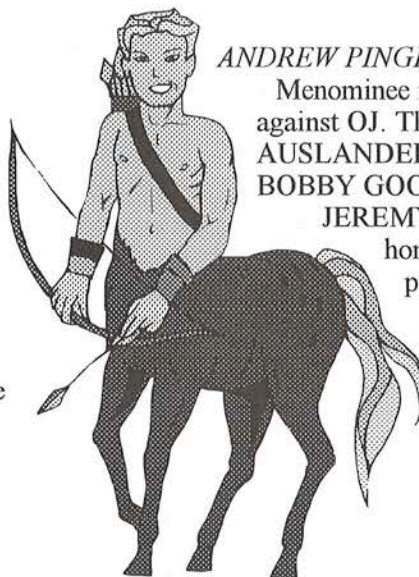

ALEX YUSPEH batting in the amazing 13B comeback



13B Game In A Word? WOW!

EVAN HERMAN—

Play ball! was the shout from Menominee's own EDDIE WHITE, the umpire. The 13B softball game had begun. OJ went up first and was held scoreless. PHILIPPE IFERGAN led off with a single and got one of the two runs scored that inning. OJ then struck back with a three run inning. Menominee then went on a cold streak, and OJ ran up the score. We went into the sixth down 10-2. Ojibwa scored one run making it 11-2.

Ojibwa got two outs. Then BRYAN SIMKIN came up and rocked one deep to center field making the score 11-3. We then went into seventh and shutout OJ. Then coach JON KULESZA gave the team a pep talk. He inspired the team! We got one run quickly, and then we loaded the bases for

SIMKIN who hit a grand slam to make the score 11-8. We then got two runs. TED ROTH then scored the tying run. In the eighth, Menominee held OJ scoreless. It was our turn to bat, and EVAN HERMAN led off with a double. He then advanced to third on a sacrifice.

Menominee was then in position to finish off one of the greatest comebacks in inter-camp competition ever. OREN JACOBSON stepped up to the plate and hit a line drive into left center scoring HERMAN easily from third. Menominee won!!

The mass crowd that had assembled out at the new Al Lewis Field stormed the winning team as an on field celebration took place. 13B had made a miraculous comeback to win 12-11!

16A Sweeps OJ!

BEERS—

It was a beautiful day at OJ for a softball game. We had beaten OJ a couple of weeks ago in a close game. We were confident, but not cocky. In the first four innings, our defense was dead. We had one run. We were down four to one, but our spirits were still up. Then in the top of the fifth we scored five runs. STEW "NATE" AUSLANDER led off the inning with a home run. MATT PASSEN then got on base and scored. We had two runs in the sixth. At that point we went up 8-4, but OJ was still in reach. Then the nail in the coffin. Top of the seventh, GABE POLSKY got on base and BOBBY GOODMAN hit a two run homer and Menominee went up 10-4. But the game was not over yet. In the bottom of the seventh, OJ scored five runs against our solid defense. ARI ROSEN was near perfect on the mound for Menominee, and CORY PROVUS and ALAN TRUBOW put on a hitting clinic on how to hit the ball hard and on the ground. Overall, Menominee 16A 2, Ojibwa 16A 0.

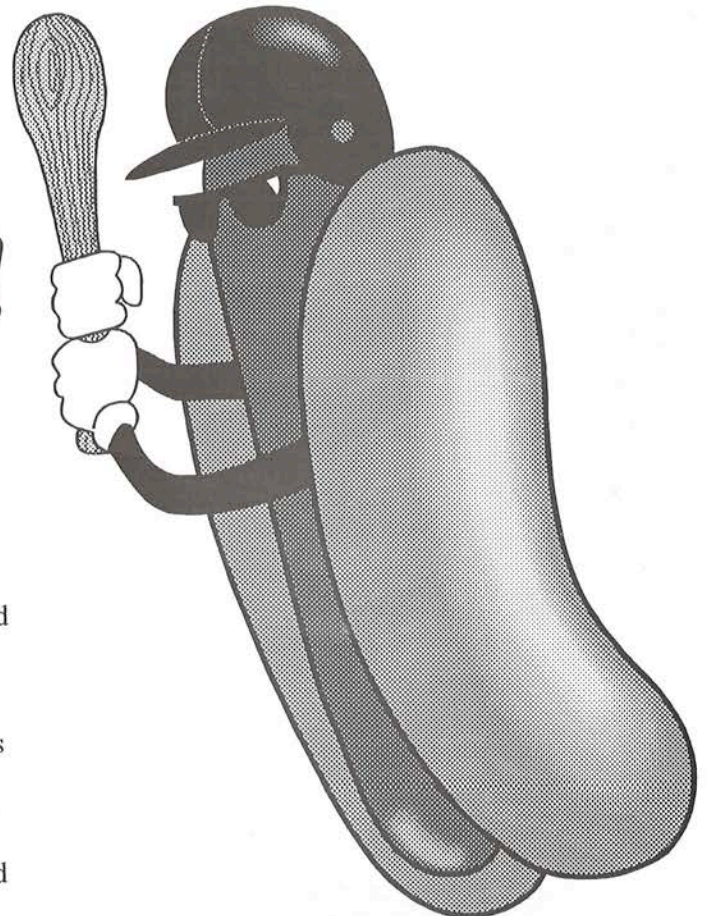

Young Tennis Studs Savor Sweet Success

JARED RALSKY—

Menominee's 11 and under tennis squad collided with Ojibwa's team. The Menominee team consisted of great players like MIKE WEINER, JON SIEGEL, JOSH BENJAMIN, and SAM YUSPEH. The doubles teams were: DANIEL ROSEN/JARED RALSKY, JAY GUSTAFSON/ SCOTT SCHAFF, and the #3 doubles, ELLIOT LEIBERMAN/ MATT HOLLANDER. MIKE WEINER beat DOUG BAUM 6-4. JON SIEGEL lost 6-1. JOSH BENJAMIN won at #3 singles and SAM YUSPEH won at #4 singles. DANIEL ROSEN and JARED RALSKY lost in a hard fought match 6-4. MATT HOLLANDER and ELLIOT LEIBERMAN played hard but lost in a tiebreaker. Menominee won 4 matches to Ojibwa's 3. Everyone played hard and the victory was well worth the effort!

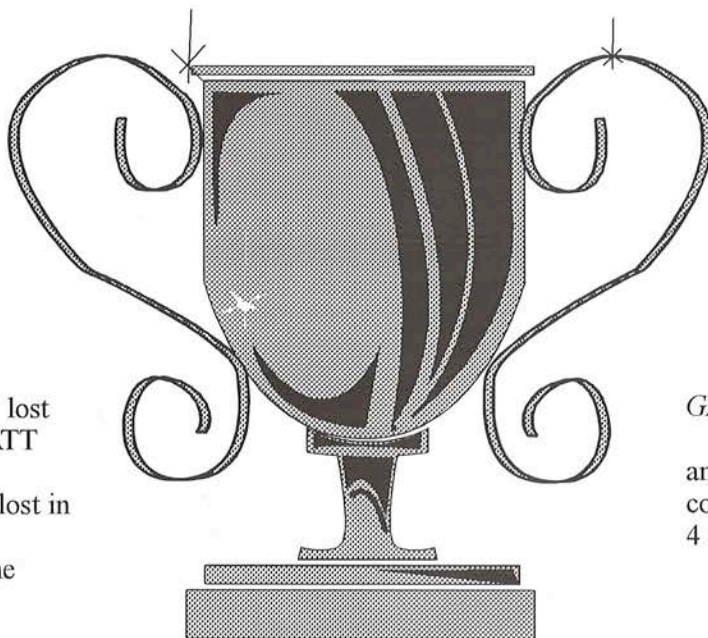

13 Tennis Serves Up Awesome Birthday Gift For Phillipe

ANDY ZLOTNIK—

The afternoon tennis competition with Ojibwa started out on the JIM "BUZZ" WYETH courts, and it was there that the mood of the day started "PER USUAL" for Menominee's tennis team. We came out ahead once again, but not without a strong fight from Ojibwa. In the singles competition, Menominee and OJ tied at two a piece. Menominee's two wins came from MATT ROTHSTEIN. It was up to the doubles team to pull through with the victory. BRETT CHETEK and PETER EHRLICH cruised into an easy victory in the number two doubles spot. But with tough losses from BRIAN ANDALMAN, SIM DARWICK, SETH

RHEINGRUBER, and ZACK WEINER, the event was all tied up at three all. The stage was set for a pressure cooker match played by "Birthday Boy" PHILIPPE IFERGAN and JON JAPHA. In the normal "JAPHA" style, the match came down to the end with the score 8-7 Menominee. JON served up an ace and the match soon was over. PHILIPPE was so overcome with joy that he broke down crying on center court. It was an amazing Birthday present and a great match to have witnessed!

Seniors Insure Tennis Sweep At Ojibwa

GARY "TONE" TUNER—

Today Menominee's tough 16 and under tennis team took to the courts at Camp Ojibwa. We played 4 singles and 3 doubles.

In the singles matches, ALAN TRUBOW played as well as I've seen him, and with a smile on his face, won 8-2.

CORY PROVUS, #2 singles, played really intense and won with a 7-6. JEFF

DAVIDSON peaked at the opportune time to win 8-4. While GABE POLSKY, on the lake court went down 3-8. With the doubles PASSEN/ LEZAK took an early lead but let it go and lost 5-8.

SCHREIER/ SMITH were delighted with their 8-5 victory. The final match was delayed but STERNHELL/ ROSENBERG stayed focused to win 8-4. The 16 and under meet



PHILL STERNHELL had his game face on in his tennis match vs. OJ

final score was 5-2 in favor of Menominee and a great result for the tennis program, but more important for the camp!!

11C Softball In Huge Comeback Takes OJ In Extra Inning

BOB EMERY—

The 11C softball team strutted their stuff at Ojibwa. With great crowd support, the phenomenal 11C team won in the eighth inning with the final score being 11-7. Menominee held the lead until the seventh inning, when Ojibwa tied the score at seven. Menominee's 11C decided they had had enough and finished strong with a four run top of the eighth. MARTY WEISMAN came away with the only home run and CHAMP SUMERS received the win for his great pitching. The middle infield played fantastic with JARED OLIAN and MIKE HIRSH playing second and

ADAM GREENBERG playing short stop. Playing the corners were MARTY WEISMAN at first and JARRET TURBIN at third, both played an incredible game. STEPHEN GOLER played right field excellently and backed up first base on every play - a coaches dream. JOE KLEIN kept the team pumped throughout the game, and ROB KOHEN ran the bases like a pro.

Those who cheered for 11C should also be recognized due to their immeasurable importance in helping our team to win.

13A In Pitcher's Duel



SIM DARWICK focuses on the ball in the 13A game.

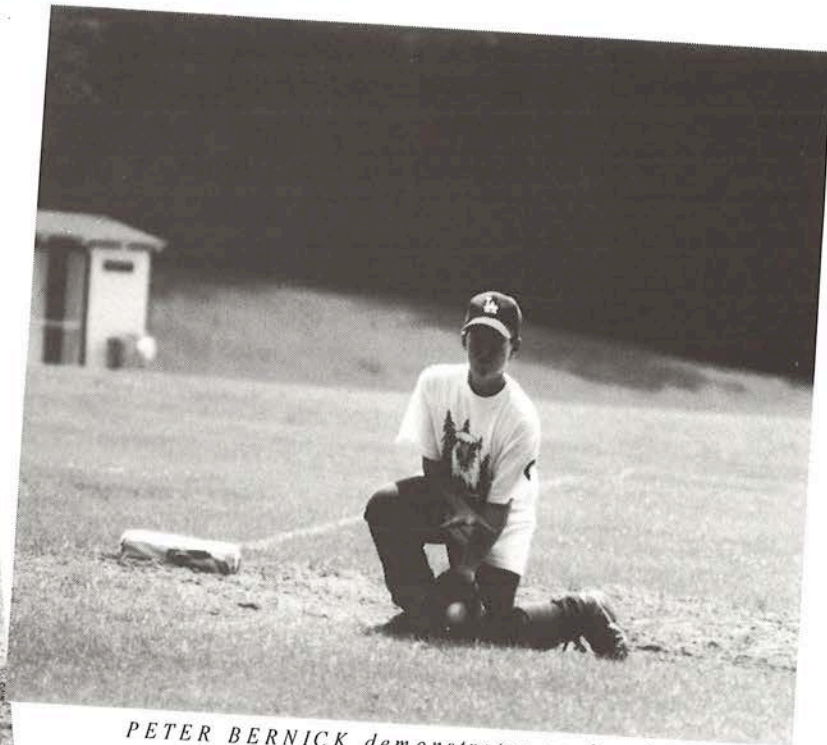

PETER BERNICK demonstrates perfect form for fielding a ground ball during the 13A game.

BOUTROS—

A re-match was inevitable. The 13A had vengeance in its heart and a heart full of pride. OJ had taken the first game easily. This time was to be different. A re-tooled lineup and a change in personnel led to a more potent offense.

BRIAN ANDALMAN led off with a single and it seemed as everything was going our way from the start. But, over the next six innings, we could only muster three more hits. SETH RHEINGRUBER and BRIAN ANDALMAN each had two hits. SETH pitched a gem as

he only allowed two runs. But that was all OJ would need. It seemed every hard shot we hit was stolen out of the sky. PETER BERNICK, JON JAPHA, and BRETT CHETEK kept the left side of the field an essential wall of defense. But in the seventh inning, LARRY MILLER came up with two outs and blasted a triple to left center. But the excitement was again torn away as COLIN TAHI'S shot up the middle was backhanded blindly by the pitcher. Although the final score showed OJ on top, this coach could be not more proud of his team. Next year, boys, next year.

18 ROBIN HOODS ENJOY HOME TARGETS

ANDREW PINGER—

The ever calm HERBIE LUKES opened round two of the 1994 13 and under Menominee vs. Ojibwa archery team competition.

HERBIE coldly squeezed out 2, 6 arrow rounds of 48 and 44, for a total of 92. This, the highest mark of the day, was shared also with Ojibwa's fifth shooter, BERNARD. Lefty archer, JON FELDMAN took to the 20 yard line to dazzle the competition with his skills, and graced the score card with an overall 64. JEREMY GLAZMAN and team newcomer, DAVE DAVIDSON, matched scores with 74's, while STU



EMMERMAN just missed the 3 way tie by shooting a heartbreaking, but wonderfully decent, 72. The real story, of course, is BRYAN SIMKIN. BRYAN was disappointed with his score of 88, but it turned out to be just enough to send the team "soaring" over Ojibwa Squad by a score of 464 to 421.

Team unity was strongly apparent as all members helped focus on the victory. Special thanks to team alternate ANDREW BENDER for supplying morale boosting at those critical times.

Thanks man, you're a gem!

C.M. Squeezed By OJ

DANIEL ROSEN—

It was the second glass of OJ. Menominee played a good first two innings. We started off at bat. MIKE WEINER led off with a single followed by ANDREW DRAFT'S base hit. Then with one out, big ELI PLATT cleared the bases with a triple scoring two runs. At the end of the inning it was 3-0 Menominee. The first batter for OJ struck out on MIKE WEINER'S moonball. The next two OJ batters were retired on fine defensive plays to end the inning, made by SCOTT SCHAFF and MIKE WEINER.

The next two innings no runs scored, but in the fourth, OJ exploded with six runs. The following inning, OJ added another two to make the score 8-3. The seventh provided Menominee's last chance to come back. Led off by JAY GUSTAFSON'S single, a rally was started. Menominee, however, could only manage two runs before the final out, and the game ended with OJ winning 8-5.

11B With A Valiant Effort

STEWART AUSLANDER—

As the confident 11B softball team took to the field, they were met by a strong team from Ojibwa. BRETT RHEINGRUBER was tough on the mound and was backed up in the field by MIKE REICH at catcher, BRETT "SCOOTER" GOLDNER at first, JOSH KURZMAN at second, JOSH ZEMEL at short stop, DOUG LEVIN at

third, JOHN WALTON in left, JUSTIN HOROWITZ in center, MIKE HERTZ in right, and ELLIOT LIEBERMAN in short center.

Despite the valiant of the starters, plus the great play of JEFF DAVIDSON, MATT HOLLANDER, JOSH BENJAMIN, JARED RALSKY, DAVE SCHWARTZ, MATT SCHWARTZ, and BRETT PESSIS off the bench, Menominee fell a bit short.



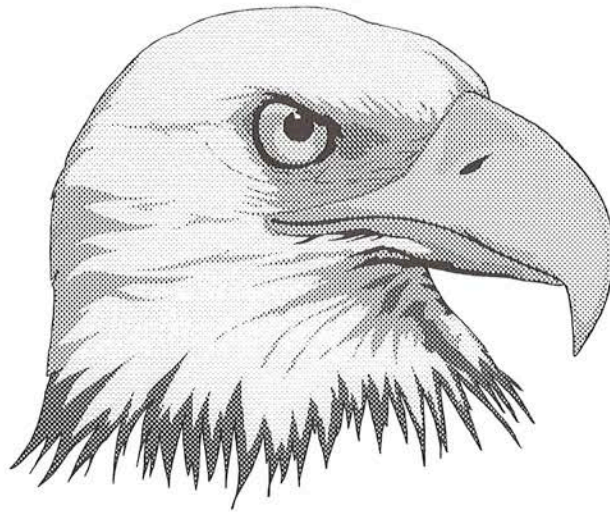

16B Soaring Eagles Fly Over Ojibwa

MIKE BURLING—

There was no late inning dramatics this time as the 16B softball team jumped out early and never looked back. With newcomers STEVE KATZ, ANDY SCHIMEL, and PHIL STERNHELL adding offensive punch, the rest of the team followed suit. In the top of the first, REID BARTHA drilled a two out shot over the left fielders head for a home run and an early 1-0 lead.

BARTHA'S round tripper gave Menominee momentum as the Eagles scored in every inning. Once again, hurler JEFF DAVIDSON kept OJ off balance with his masterful pitching. In the second, KATZ launched one over the outfielder's head and ended up on third until an AARON EAGLE single scored him to give Menominee a 2-0 lead. After OJ got one back in the bottom of the inning, Menominee got two more runs in the top of the third and one more in the fourth. In the third, EVAN ROSENBERG led off with a single which was answered by another single by DAVIDSON. One out later, SCHIMEL knocked them both in with a double. In the fourth, KATZ slugged

another triple and once again scored on an EAGLE single making the score 5-1. In the bottom of the inning, Menominee flexed its defensive muscles. With no outs and two on and two runs already scored, the momentum began to shift to OJ. However, Menominee never backed down and made two plays that ultimately won the game. First off, DAVIDSON snagged a line shot off an OJ bat for the first out. That was followed by an inning ending double play as short stop RICKY KIRSCH caught a line drive and doubled off an Ojibwa runner at first. These two defensive gems turned the tide back in the favor of Menominee. After that, the Soaring Eagles just went higher.

In the top of the fifth, JOSH ROTHENBERG delivered a key two out single that scored KIRSCH and DAVIDSON. In the sixth, KIRSCH came through with another two out hit scoring STERNHELL. The final tallies came in the seventh with ADAM SCHREIER getting a one out single that scored BEAR and KATZ. Although OJ got a run in the seventh, it was too little, too late. Menominee won 10-4.



11A B-BALL GOES INTO OVERTIME

BEAR—

It was the 24th of July, our second competition against our fierce rivals from Ojibwa and Team Menominee was ready for a battle. It was time for the 11A basketball team to take the courts. Our starting line-up included ELI PLATT as the man in the middle, MIKE WEINER and SCOTT SCHAFF at guard, and BRETT RHEINGRUBER and JARRET TURBIN as forward. It was a defensive battle from the beginning. SCOTT SCHAFF and MIKE WEINER played tenacious defense on OJ all day leaving them with an average of only nine points per quarter.

Although ELI PLATT got into early foul trouble, he was an important factor in crashing the boards. With a solid supporting cast of ANDREW DRAFT, DAN ROSEN, MATT BERCOVITZ, and JOSH KURZMAN, 11A gave its all, pushing the game into overtime. But, Ojibwa's offense proved to be a little too much for us as they finally defeated Menominee 36-30.

Although Menominee lost the game, a moral victory was won because of the excellent attitude and spirit presented by the team during the game.

11B SENDS MESSAGE

CORY PROVUS—

As the 11B basketball team headed into competition against OJ for the second time, this go around they knew that they were a much better and more intense team. The starting line-up for Menominee was DOUG LEVIN, ERIC ISRAEL, JARED RALSKY, "SPUD" HOROWITZ, and the captain of the team, ADAM WEINGARTEN. Right off the start, OJ came out running. So then, we started to crash

the boards and our man on the boards was in the form of JON SIEGEL. As the game progressed, our speed was weakening, so we brought in our specialist, JON WALTON. But in OT, the OJ team was just too strong. Their experience and intensity was just too much. Even though Team Menominee went down, our basketball team sent a message to OJ. We look forward to playing them again next year.

ABES AND NATE MADE PROUD

GREG ABRAMS—

Fired up, determined, and totally focussed, the 11C basketball team took the court against a tough OJ squad. The starting five consisted of ERIC STANG, JAY GUSTAFSON, MIKE REICH, BRIAN "CHAMP" SUMERS, and SAM YUSPEH. They did a fantastic job bringing the ball up the court against tenacious defense. STEPHEN GOLER and JOSH BENJAMIN provided a quality spark off the bench. Many easy buckets were scored due to quick ball movement from the whole team, especially MATT SCHWARTZ, HARRIS KEALEY, and ROB KOHEN. After a hard fought game, Menominee came up on the losing end of the scoreboard. However, these guys never looked down and stayed tough the whole day. STEW AUSLANDER and GREG ABRAMS, the coaches of 11C, could not be prouder.



Coach STEW AUSLANDER sketches a play during a time out.

11D DOWNED BUT NOT OUT

ROSS AUSLANDER—

The stage was set. The air was ripe for a re-match. The only difference was that we were at OJ. We had the crowd against us, but we fought against it. Throughout the game the coaches of 11D, ARI ROSEN and ROSS AUSLANDER, kept in a "big" line-up, including BRAD ROSS, JORDAN ROTHSTEIN, and newcomer JOSH HELLER. At the beginning of the roller-coaster, we came out fighting. JOE KLEIN, our starting point guard, shot the ball from nearly out of bounds - SWISH! We saw some good omens. Unfortunately, we came up short in the end. On the other hand we only lost by four points, 42-38, which is a major improvement from last time. If we played OJ again we would definitely take it to the wire. Coaches ROSS AUSLANDER and ARI ROSEN were quite proud of the team because even though they lost, they played tough and never gave up.

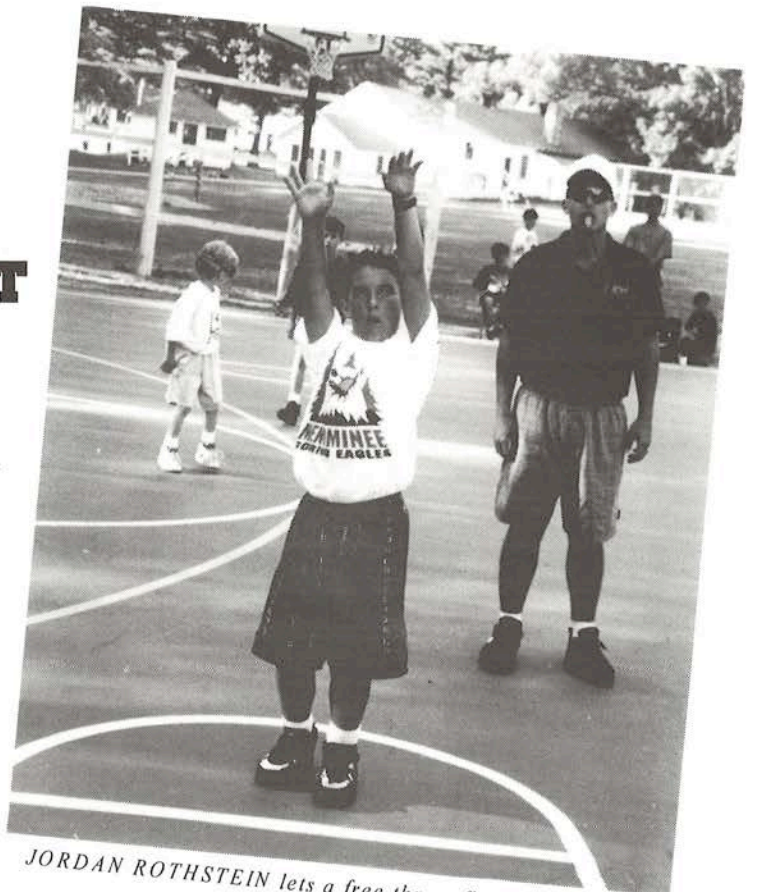

JORDAN ROTHSTEIN lets a free throw fly in the 11D game



13A BUCKETS NEVER QUILTS

BARRY QUAYLE—

After a 37 point loss to Ojibwa last time, Menominee's 13A basketball team sought to improve on their performance in a re-match at the Friendly Confines. In the game, COLIN TAHI was an MVP, scoring 15 points and playing solid defense. LARRY MILLER was our big man down low, scoring 12 points. MATT WEISS, BRAIN ANDALMAN, SIM DARWICK, and OREN JACOBSON were the difference off the bench. ROSS SIDER and HARLEY ROSENTHAL were the key outside shooters for us. The final score was 68-44.

We put up a fight and never quit.



PROVUS' THREES LEAD WAY

"H"—

Coach "H" found himself very excited to challenge the boys from the other side of town in the 16B basketball game. The intensity level was high, the excitement level was increasing, and the crowd was overflowing onto the court - all there to see CORY PROVUS launch the three. This occurred several times as out hero was relentless on the defensive end and confident on offense. His teammates, MATT PASSEN, RICK KIRCH, GREG ABRAMS, REED EDWARDS, ARRON EAGLE, JEREMY FRYDMAN, and JEFF HOOD were all cheering him on as he electrified the crowd. The supporting cast all put on an effort as PASSEN's aggressiveness caused several OJ turnovers. GREG ABRAMS proved his value as he made many slashes to the basket for scores. But then it was PROVUS canning three after three. In all he was seven of eight from long range. Enough to keep the Soaring Eagles in the game. Unfortunately OJ's fast break combination was too much for the Eagles to overcome as we went down 56-51.

Great efforts were put out by big men AARON EAGLE and JEFF HOOD, also REED EDWARDS was monster of aggression. When the game was over this team of Soaring capacity held their heads up high and said "We played as hard as we could and have NO regrets."



13C BASKETBALL PLAYS FIRED-UP

DOOGIE—

The 13C basketball team from Menominee matched up with a well prepared OJ team. Menominee had fire in their eyes and eagerness in their hearts as they took to the court. New recruits ROSS EDWARDS, BRAD MENDEL, MIKE SOLOVY, and BRYAN SIMKIN also provided a spark to the team. Menominee got off to a slow start, with OJ taking a quick lead. JOE ROSENBAUM, DANNY LEVY, and BRETT CHETEK helped keep Menominee up mentally and hustled all over the court. RYAN HOLZ was extremely tough down low and scored frequently. JOHNNY SCHATZ

and TODD SCHWARTZ played aggressively on both ends of the court. DAVID DAVIDSON, MATT FRANK, JEFF DRITZ, and BARRY SCHWARTZ all stepped up in the fourth quarter.

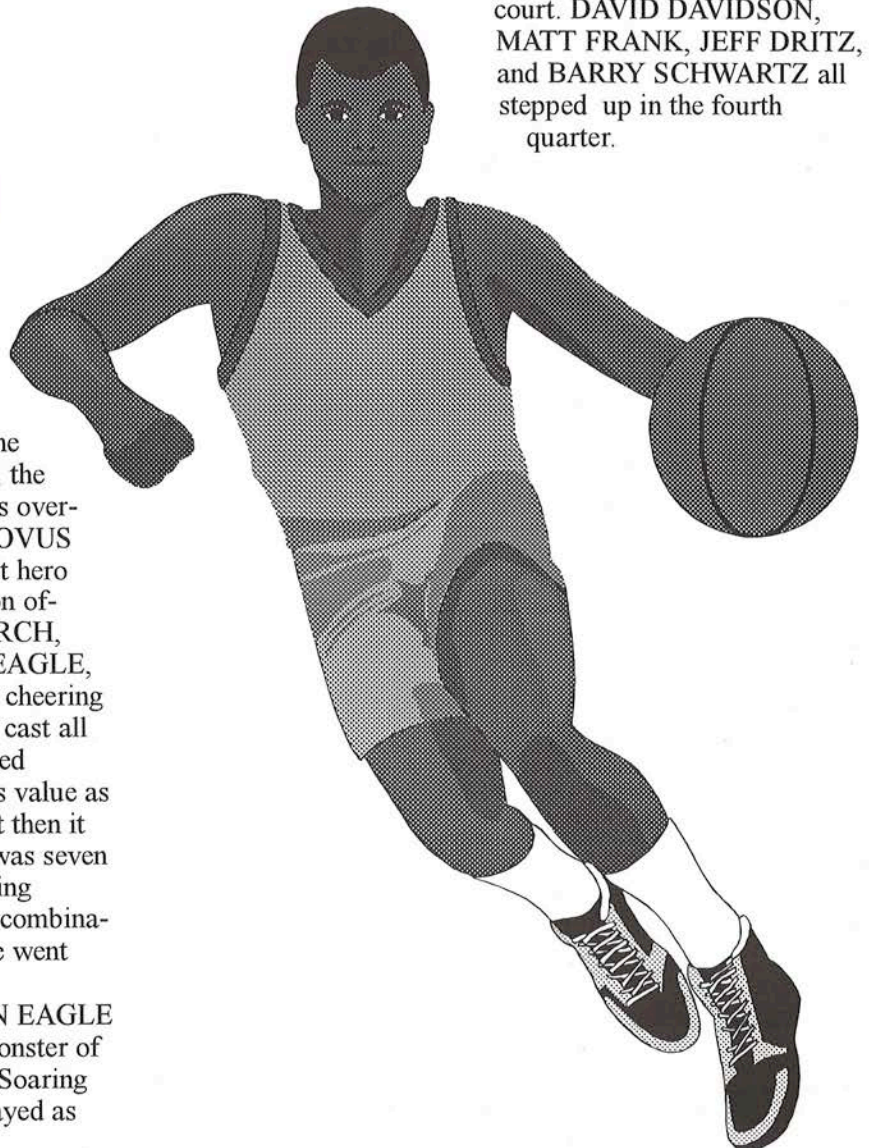

MENOMINEE SPIRIT LIVES THROUGH 13D HOOPS

EDDIE WHITE—

The 13D basketball team gave it their all. Led offensively by EVAN HARRIS and JOSH MERSFELDER, the Menominee offense did its best. However, it was the attitudes of players like ADAM KAPLAN, JASON KUMMER, RONJON DATTA, and PETER EHRLICH that proved that Menominee spirit never dies.

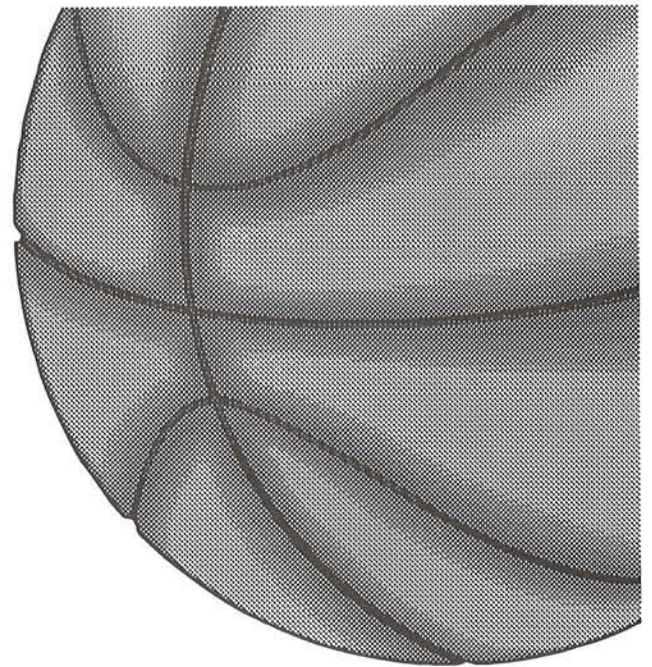

16A Coach MARK CHAPIN talks with his team

ELDEST HOOPERS GIVE IT ALL

CHAPS—

Round 2. Menominee took the court for the second time against Ojibwa within two weeks. However, this time the Green and White would hit the hardwood at OJ. REID BARTHA, ARI ROSEN, ALAN TRUBOW, STEW AUSLANDER, ANDY SCHIMEL, and JASON "BEAR" SCHWARTZ were prepared for the confrontation.

The Soaring Eagles started out tough; jumping out to a 14-2 lead. The initial surge was lead by three pointers by ARI ROSEN and STEW AUSLANDER, and many two pointers by REID BARTHA, ROSS AUSLANDER, and ANDY SCHIMEL. However, Ojibwa held tough. OJ put a

tough press and impressive match-up zone, which cooled off our boys.

At the half, Menominee trailed 26-20. Again, Ojibwa came out with an intense press which prevented our boys from attacking. Going into the fourth quarter our Menominee 16A trailed by 14. A late fourth quarter surge led by BARTHA who poured in ten consecutive points, fell short as Menominee lost the game by a respectable 14 points.

Overall, the boys of Menominee fought hard. Their persistence and unwillingness to quit shined throughout the game and made their coach extremely proud. Outstanding effort by all!

16C SQUAD DOESN'T SQUANDER EFFORT

FRANK JOHNSON—

The 16C basketball team showed a lot of guts and heart. BOBBY GOODMAN, JEFF DAVIDSON, and GABE POLSKY came out fired up. However, the OJ team with their home court advantage were bigger and stronger and over-matched the Eagles.

LEONARD FIALHO and DAVID LEZAK played tough for being younger than every OJ player. All players involved gave it their all. In the end, the scoreboard read OJ 48, Menominee 30.



JESSE LATORRE, JARED OLIAN, MIKE REICH, and MARTY WEISMAN take a moment to relax during the OJ competition

MEGAPHONE

G & W TO THE STARTING BLOCKS EDITION

JULY 25-26, 1994



Green And White Pennants Signal Start Of G&W!



ELI PLATT, DANNY LEVY, TREVOR ABRAMSON, EVAN HARRIS, and JOE KLEIN find out their teams.

On Monday, it seemed just right to start the grand daddy of all camp competitions, Green and White. As the camp was released into Prime Time activities this afternoon, several campers noticed that names were listed on the backside of the pennants hung on a line around the new sports rink. Green and White had started! The overall

captains for the Greens are MATT PASSEN and EVAN ROSENBERG, for the Whites, PHILIP STERNHELL and JEFF DAVIDSON. This year's competition will be filled with events including the traditional ones like the sing on the Relay as well as great ones like the Spelling Bee and Counselor Hunt.

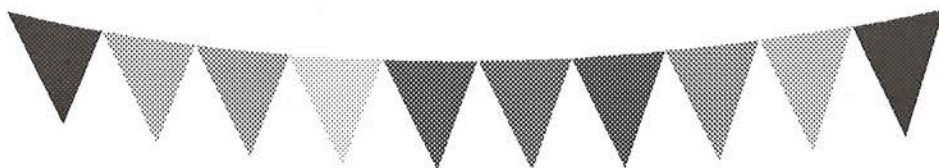

Captain's Grand Slammer Leads Greens To Triumph

EVAN ROSENBERG—



Green and White this year kicked off with the traditional first event, the All Camp Hardball Game, the first ever on new Al Lewis Field. The Whites won the coin toss and chose to take the field first. The Whites fell behind right at the start. However, the Greens could only manage four runs until the young seniors came to bat. The mighty JORDAN GOLDFARD stepped up to the plate and hit a shot down

the third base line that rolled to the fence. GOLDFARB got an in-the-park home run. The next big hit that came from the Green team co-captain EVAN ROSENBERG who nailed a grand slam home run.

Then the Whites came to bat, and the score was 48-46 in favor of the Greens after JEREMY FRYDMAN hit a ball that has landed over the left field fence of new Al Lewis off pitcher FRANK JOHNSON. But this blast was not enough, as the Green team took the All Camp Hardball Game.

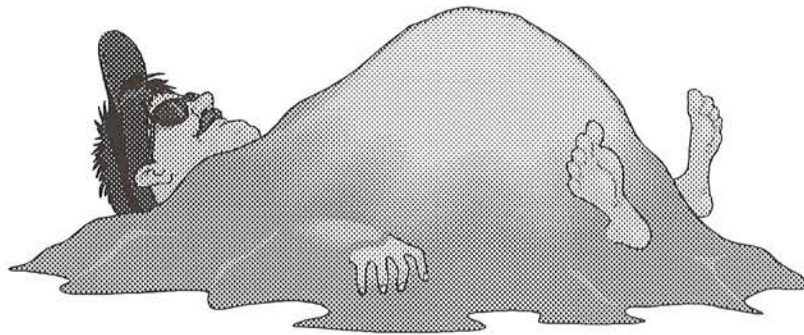

Sand Lake Sand To Green Liking

ZLOTY—



Every year Menominee breaks itself into two teams, Green and White and battles it out on the courts, fields, and sand to see which color is the brightest. One event in the annual competition that is new this year is the Sand Castle Building Contest. Each team was broken up by age group and given 30 minutes to make a sand creation. This year on the shore of Sand Lake we saw some unbelievable sand creations. The Green team used their talents to create sport logos. The "Old" seniors fashioned the logos for all of the MCAA Leagues, the MBA, MHL, MLB, and MISL. Whereas the Green opted for sports, the Whites went for the traditional mountain and castle building. The highlight of the event was the 13 year old Green team creation which was a Bulls' logo. The team, headed up by SETH RHEINGRUBER, created an excellent likeness of the Bull on the sand.

After the sand had settled, the judges went with the sport logos and gave the Green team the win.

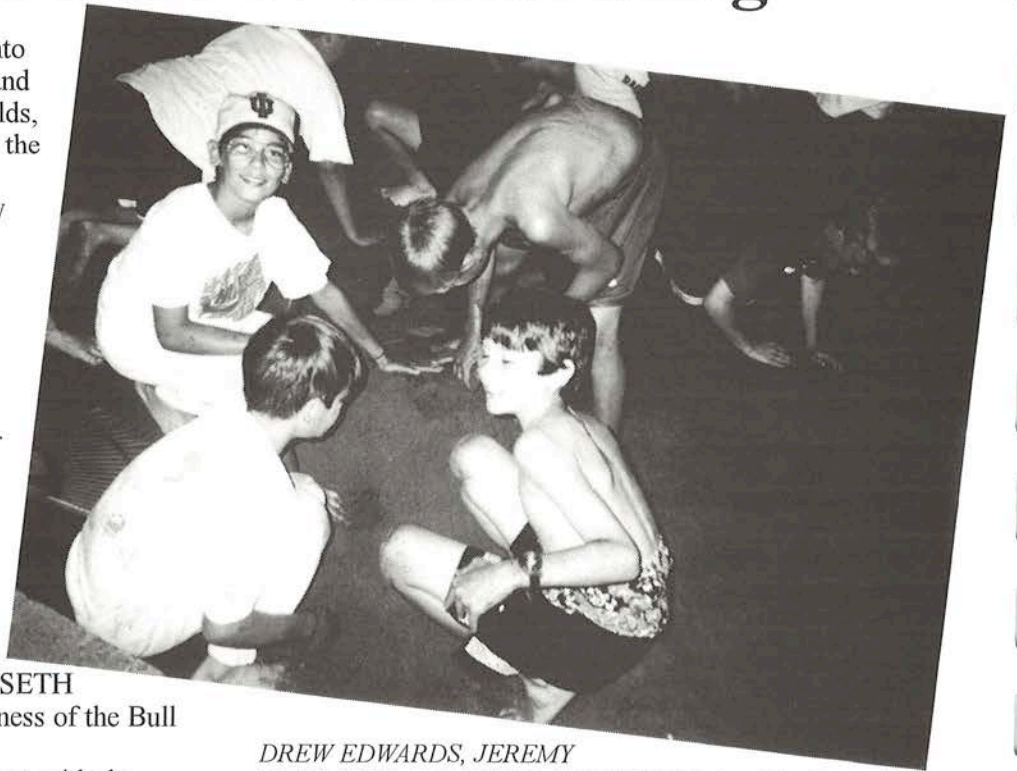

DREW EDWARDS, JEREMY MATIMORE, and JAVIER BASAGOITI helped the Green Team create the winning "sand creations."

BRIAN ANDALMAN and ROSS AUSLANDER
went head to head in the Spelling Bee.

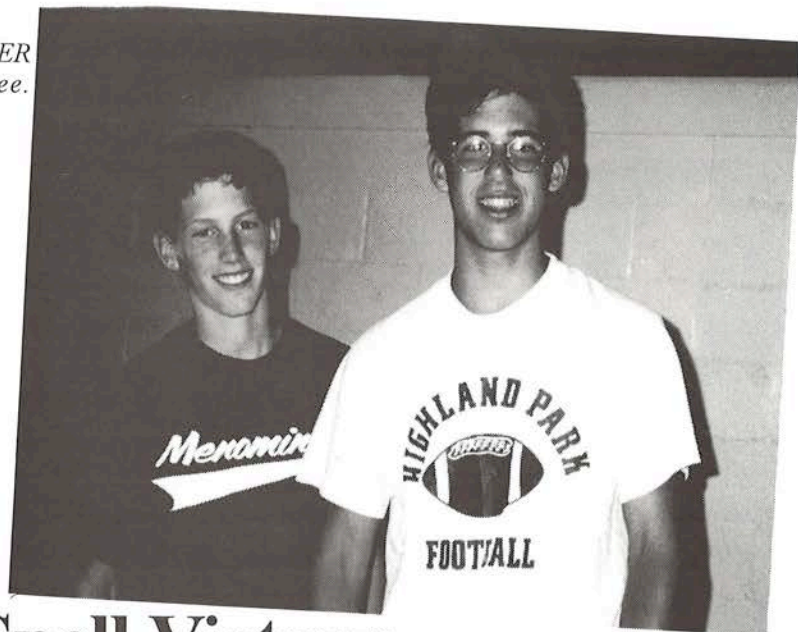
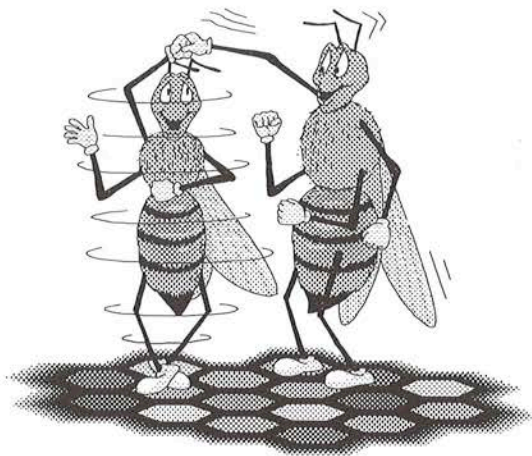

Whites Spell Victory



The Green and White Spelling Bee proved to be a crucial event in this year's Green and White competition. With a total of 18 competitors from each team (17 campers and one counselor), spellers prepared for the worst as ARI BERNSTEIN gave them some difficult words. Early dismissals from the bee were caused by words such as: bourgeois, vicissitude, hebdomadal, maneuver, potpourri, and dauphin. As the ranks thinned on both teams it turned into a one on one

competition between BRIAN ANDALMAN of the Greens and ROSS AUSLANDER for the Whites. Words such as dhole (no, that is not a type-o, it's spelled d-h-o-l-e), philter, phenolphthalein, desuetude, sforzando, baccalaureate, immew, and bouillabaisse provided some major challenge to the competitors. Ultimately, the word that determined the outcome of the bee was garrulous, which was spelled correctly by ROSS AUSLANDER after ANDALMAN had missed it. The Spelling Bee went to the Whites.

1994 Greens



JUSTIN HOROWITZ
ROB KOHEN
JAMES MC GOVERN
ERIC STANG
BRANDON DAVIS
ANDREW DRAFT
HARRIS KEALEY
JESSE LATORRE
JOSEPH KLEIN
JUDAH KLEIN

BRIAN ANDALMAN
JOE JACKSON
DAVID LEZAK
ELLIOT PESSIS
BRANDON SMITH

JAKE GOLDNER
JEFF HOOD
RICKY KIRSCH
ENRIQUE OJEDA
MATTHEW WEISS
AARON EAGLE
BOBBY GOODMAN
MATT PASSEN Capt.
GABE POLSKY
EVAN ROSENBERG Capt.

MATTHEW HOLLANDER
ELLIOT LIEBERMAN
BRAIN SUMERS
ADAM WEINGARTEN
SAM YUSPEH
JAVIER BASAGOITI
MATT BERCOVITZ
GEORGE BURDEN
JOSH KURZMAN
JONATHAN WALTON
MARTY WEISMAN
JOSHUA BENJAMIN
DREW EDWARDS
MATTHEW KLEIN
JEREMY MATIMORE

JARED RALSKY
MATTHEW GOODSTEIN
JAY GUSTAFSON
BRETT RHEINGRUBER
JON SIEGEL

BRAD BROOK
TOM BUDASZ
JORDAN GOLDFARB
JOHN PATRICK JACOBS
ENRIQUE LONA
TODD SCHWARTZ
JAMES DICKEY
ROSS EDWARDS
SCOTT KAPLAN
SETH RHEINGRUBER
JOE ROSENBAUM
DAVID DAVIDSON
EVAN HERMAN
HERBIE LUKES
JOSH MERSFELDER
BRIAN TEPPS
MATT COHEN
JEFF DRITZ
LARRY MILLER
TED ROTH

MATT ROTHSTEIN
ZACK WEINER

PETER BERNICK
JONATHAN FELDMAN
DAVID SCHWARTZ
MICHAEL WEINER
BRIAN WHITE
SIM DARWICK
MANUEL ESCALANTE
EVAN HARRIS
ETHAN HOROWITZ
JEREMY GLAZMAN
JEFFEREY HERTZ
OREN JACOBSON
KEI KATO
JORDON GAULE
MATT KAUFMAN
JAKE NEIMAN
MICHAEL SOLOVY



1994 Whites

MICHAEL MASON
 AARON PERNA
 ADAM SCHREIER
 TODD BLOCK
 NICK HOUCHEMS
 JON JAPHA
 ANDY SCHIMEL
 REID BARTHA
JEFF DAVIDSON Capt.
 JEREMY FRYDMAN
PHILIP STERNHELL Capt.
 JOSE VILLAVICENCIO

CHRIS DICKEY
 MICHAEL HERTZ
 PABLO MAYO
 COLIN WEINER
 RENE HERTSBERG
 DOUG LEVIN
 ELI PLATT
 DANIEL ROSEN
 NICHOLAS TALBOT
 JARRET TURBIN
 JEFF J. DAVIDSON

BRETT GOLDNER
 ADAM GREENBERG
 CASEY HINTZ
 BRETT PESSIS
 SCOTT SCHAFF
 JASON HORN
 BRANDON LEVY
 BRADLEY ROSS
 JEFFERY STEIN

JOSE BASAGOITI
 MATTHEW GROSS
 JUSTIN JACOBSON
 TODD RHEINGRUBER
 BARRY SCHWARTZ
 ROSS SIDER
 TREVOR ABRAMSON
 RONJON DATTA
 LEONARD FIALHO
 HARLEY ROSENTHAL
 ALEX YUSPEH
 ANDREW BENDER
 STUART EMMERMAN
 DANNY LEVY

BRAD MOSS
 BRYAN SIMKIN
 BRAIN ANDROW
 MATT FRANK
 PHILIPPE IFERGAN

ANDRES ARAIZA
 BRETT CHETEK
 PETER ENRLICH
 JORDON GRANT
 MATT FINDER
 STEPHEN COLER
 DAVID KRAUT
 JASON KUMMER
 MICHAEL HIRSCH
 RYAN HOLZ
 JUSTIN MATIMORE
 JOEL SORINSKY
 ADAM KAPLAN
 BRAD MENDEL
 ANDY SLUSSER
 STEPHEN STEIN
 CRAIG RASHKOW
 JOHNNY SCHATZ
 COLIN TAHI

JEREMY EMER
 ERIC ISRAEL
 MICHAEL REICH
 JORDAN ROTHSTEIN
 JOSH ZEMEL
 JUSTIN CLOUSE
 JOSHUA HELLER
 JARED OLIAN
 MATTHEW SCHWARTZ
 JACOB KLEIN

DAVID CHERNER
 REED EDWARDS
 STEVEN KATZ

Twilight League Standings

Junior

	W	L
Zephyr's Soaring Eagles	5	2
Jordan Nike Flights	3	4
Spud's Potatoes	2	4

Intermediate

	W	L
North		
Jay's Lay's potato Chips	5	1
Grant's Giant Gonzangas	3	3
Ethan's Enormous Ear Eating Eels	2	4
Turbin's Tornados	1	5

South		
Lieberman's Iethan Lasagna Lumps	4	2
Gaule's Gill-Gutted Gefilte Fish	3	3
Sorinsky's Study Sundials	3	3
Schaff's Salivating Superstars	1	5

Trade Update:

JARED RALSKY to GUSTAFSON
 ROSS EDWARDS and JEFF STEIN to SCHAFF
 WALTON to LIEBERMAN
 MIKE HERTZ and KEI KATO to SORINSKY
 SAM YUSPEH to HOROWITZ

CORY PROVUS is the new G.M. for GUSTAFSON
 GREG ABRAMS is the new G.M. for SORINSKY

Advanced

	W	L
Alex's All-American All-Stars	5	1
Teddy's Terrorizing Torpedoes	3	3
Philippe's Flying Flapjacks	2	4
Millhouse Martyrs	2	4

Trade Update:

JOSH MERSELDER to YUSPEH
 JOHNNY SCHATZ to MILLER



GM JOSH ROTHENBERG directs Junior Twilight League commissioner FRANK JOHNSON'S pitch to rookie sensation JOSH HELLER.

Whites Hunt Down More Counselors

CARL "RAWHIDE" ROWLAND—



The long awaited Counselor Hunt began on the evening of the 26th of July. The camp went crazy when GLENN announced what would take place that evening. A few high pointers were marked out for hot targets - "H" who was worth a staggering 85 points. Then there was the veteran, BOUTROS GOLDMAN, who was worth 84 points. Points, by the way, were determined by taking the counselor's height in inches and adding that number to the number of years that person had been at camp.

At precisely 7:30, the counselors were let go. BARRY "BQ" QUAYLE was seen heading towards OCR as was "THE IRON FISH", NICK OLSON, who was to do his squirrel impression and climb

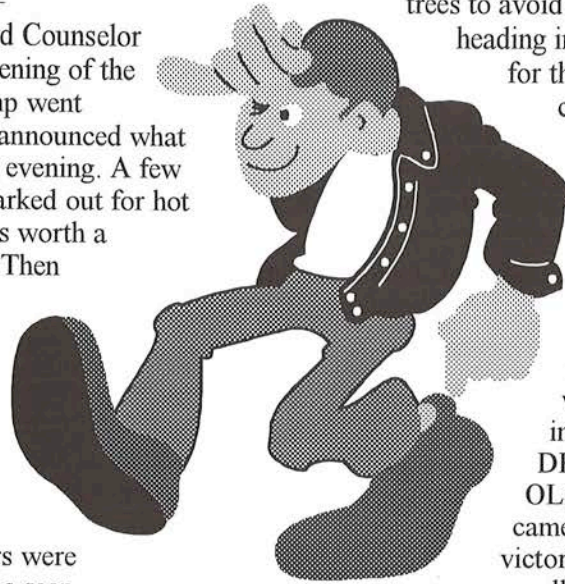

trees to avoid detection. RAWHIDE was last seen heading into the woods not to be seen or captured for the whole contest. For a full half hour the campers searched high and low, uncovering and discovering counselors like JOSH ROTHENBERG, who ran kamakaze across the gully. Others like BOUTROS, ZLOTY, NATE, and EDDIE WHITE were all found. Unlike others, this year saw many uncovered counselors like ROB EMERY who climbed into a hole and covered himself with leaves and sticks. Other survivors included BQ, who hid under a bulldozer, DROR, ALAN TRUBOW, BQ, and NICK OLSON. After the thirty minutes, the time came to count the score. The White team was victorious and so gained a vital step toward overall victory in Green and White '94.

Whites Have Monopoly As Menominee Turned Into Board Game

ROB EMERY—



1994's Menominee Monopoly game proved to be an exciting Green and White match-up. Stops marked with the hokey-pokey, duck-duck-goose, the dancing bear, leapfrog, and many others helped campers have a great time running through the Friendly Confines. The intermediate Green team and the Seniors from both divisions finished on top with twenty-three minutes each. Although the Green team finished with two of the fastest times, the White team took the 200 dollars for passing go and won the contest.



JAKE NEIMAN does the leap-frog to complete Menominee Monopoly.

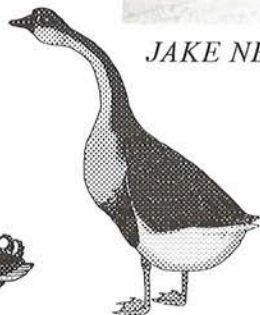
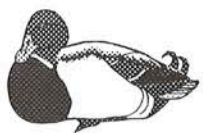

Senior

W L

Goodman's Gefilte Fried Kosher	6	0
Canned Hams	4	2
Kirshy Squirts	1	5
Reids Rampaging Water Lillies	1	5



"SAFE! No Ball!" screamed umpire MIKE BURLING on this "bang, bang" play involving MATT WEISS and ELLIOT PESSIS.

Megaphots Montage



JAKE KLEIN smiles for the camera with ISAAC



TONE TURNER gives personalized instructions during a Big 10 activity



"H" directs traffic on Picture Day '94

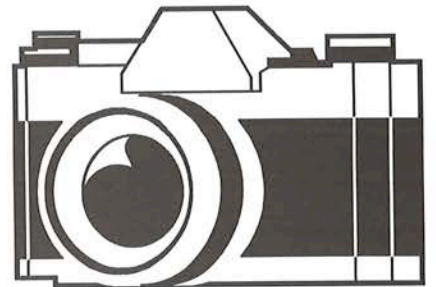

MEGAPHONE

MEGA-HAPPENINGS EDITION

JULY 27-30, 1994



16A Goes 3-0 Downs A Camp Called Kawaga

MARC BEERMANN—

After beating Ojibwa in two straight games, a 4-0 record was on everyone's mind on the 16A. Kawaga was the obstacle to an undefeated season. The first inning said it all for the boys of Menominee. Kawaga took a 1-0 lead. However, Menominee came back to score eight runs behind the great hitting of MATT PASSEN, GREG ABRAMS, ROSS AUSLANDER, JEREMY FRYDMAN, BOBBY GOODMAN, ALAN TRUBOW, ANDY SCHIMEL, STEWART AUSLANDER, and the intense man himself, CORY PROVUS. The boys of Menominee did not turn it up again until the sixth inning when we scored five more runs. Final tally, 16A-13 K-5!



MATT PASSEN takes a big cut to hit the ball hard and on the ground.

SOARING EAGLES BRAVE KAWAGA

The 16A softball team had just completed a triumphant victory vs. the boys from the Island City. Now it was time for the 16A basketball team to take the far court at the Friendly Confines. Starting for CM were ROSS and STEWART AUSLANDER, REID BARTHA, ANDY SCHIMEL, and ALAN TRUBOW. The game started off with a strong move to the basket by BARTHA, and Menominee hit the

scoreboard first.

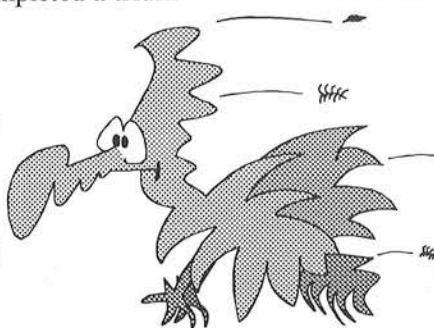

After that Kawaga was overwhelming with their swarming defense and excellent three point shooting. Off the bench, came ARI ROSEN and MATT PASSEN for scoring punch, but the size and quickness of JESSE JETT and the Braves was too much for our Soaring Eagles. Kawaga did win the game, but after CM knew they had played hard and put out a great effort.

CABINS 3 & 4'S EXCELLENT ADVENTURE

MARCUS ZAVOS—

Cabins 3 & 4 went camping on a truly adventurous trip across the treacherous waters of Sand Lake using nothing but their cunning prowess and a pontoon boat.

Of incredible coincidence, we found a landing for the boat on shore where we found four or five small dwellings waiting there for us. So, we figured that this place would be a good place to stay for the night and roast marshmallows at. HARRIS KEALEY was in particular need of the warmth of a fire because of his tumble out of the canoe while coming ashore; which unfortunately soaked HARRIS but at the same time provided laughs and smiles to everyone else.

By eleven or twelve o'clock everyone was asleep. Much to everyone's delight, JOSH ZEMEL provided the wake up call at a bright and early five a.m. We returned to C.M. at eight a.m. via pontoon boat, skippered by KOZ, our hero.

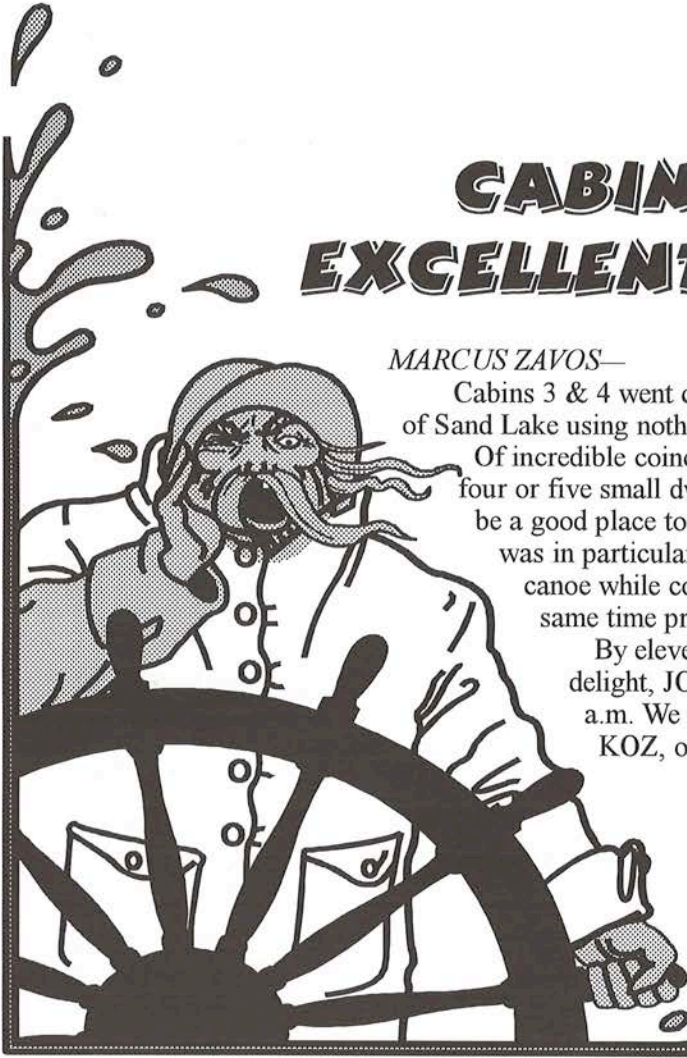

CABIN 14 TURNS SMELL INTO SWELL TOP TEN LIST

GREG ABRAMS—

It was a normal afternoon at Camp Menominee yesterday. In the Mess Hall at lunchtime, however, a distinct aroma permeated through the air from an ill-timed septic tank emptying. This smell was so horrid that GLENN was prompted to ask each cabin to come up with a list of top ten worst smells in camp that this smell reminded them of. Some of the most disgusting and hilarious included ANDREW PINGER'S sheets, FRANK JOHNSON, BARRY QUAYLE'S underwear, toe cheese, and beanies and weanies. The members of Cabin 14, JORDAN GAULE, ADAM KAPLAN, MATT KAUFMAN, KEANAN LEVANT, JAKE MEILACH, BRAD MENDEL, MIKE MESIROW, JAKE NEIMAN, ANDY SLUSSER, MIKE SOLOVY, and STEPHEN STEIN, were declared the winners with their odorific list of smells. Here we present the winning top ten smells:

10. Post TE social armpits
9. BEERMANN'S chest
8. Gary, Indiana
7. Cabin 15
6. Baby Isaac's diapers
5. Philly's dukers
4. GREG ABRAMS in his office
3. FLURRY'S tennis ball
2. The New York Knicks
1. Camp after weanies and beanies

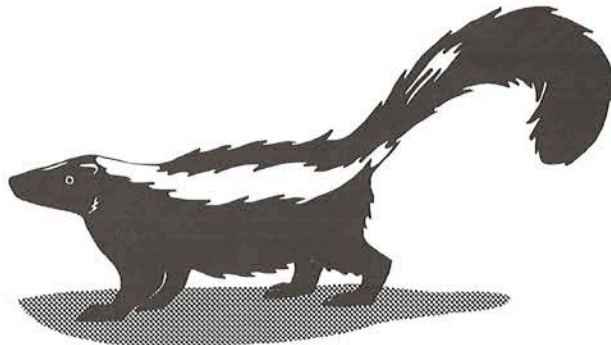

Evening with Chippewa Totally Entertaining



^ SUAVE pumps up the Chippewa girls for the nights festivities
> "Hands Up, Baby Hands Up!"



ZIP—

The Total Entertainment social with Chippewa could not have been on a more sublime night. The social started a little bit after 7:30 and ended late into the night. There was plenty of time designated for getting to know each other.

After TE took us on a trip through the Caribbean, many campers and counselors from both C.M. and Chippewa frantically railed back and forth from the YMCA. After their workout, a few were awarded with TE Camp Tour tee-shirts; ALAN TRUBOW and DAN ROSEN were just two of many privileged to get one. The Jackson Five, Olivia Newton John, John Travolta, and The

Village People were just a few of the celebrities that made an appearance. Although it was hard to detect differences in Chippewa's counselors and campers' everyone had a great time. I believe all the credit should be give to those special women in the Mess Hall (MARGO, ROBIN, JAQUELINE, and GAVIN), who made that tasty punch.



CARNIVAL AT MARIMETA WET AND WILD

ALAN TRUBOW—

Well, it was a great night on Sunday for the boys in Cabins 3-10, 14, and 15 to travel to Marimeta for a social. When the boys of summer got to Meta, we quickly got into the swing of things with a carnival. BRETT CHETEK and SIM DARWICK hit it off with the women. Also, BRETT GOLDNER got a face full of flour. JOSH "GQ" BENJAMIN and OREN JACOBSON got into it on the dance

floor. The highlight of the night was when about 20 girls doused ALAN TRUBOW with shaving cream and almost got him to shave his legs. Then the boys of Menominee chose TRUBOW to walk the plank into the water with all of his clothes on. After TRUBOW walked the plank, the boys of Menominee put an end to the only July 31, 1994 ever in history. The social with Meta helped make it a great one.



TE RETURNS FOR MEGA SOCIAL

BRYAN SIMKIN—

On Saturday, the Senior Division had a social with the Seniors of Marimeta, Birch Knoll, Agawak, and Chippewa. Also, one boys camp Deerhorn, came so the ratio would be more conducive to socialization. The evening looked more exciting because two days before Total Entertainment performed a social for us and Chippewa. Now they were back for all these camps. The dancers were 3-D, Suave,

Missy, and Kiwi. The MC was Brett, and the DJ was Frank. Frank played great music that everyone liked. Some of the contests were weird, and some were funny. AARON EAGLE was in one contest but unfortunately finished last. Besides dancing, there was socializing of course, and food and drinks too.

In my opinion, everyone had a great time. TE did a great job!

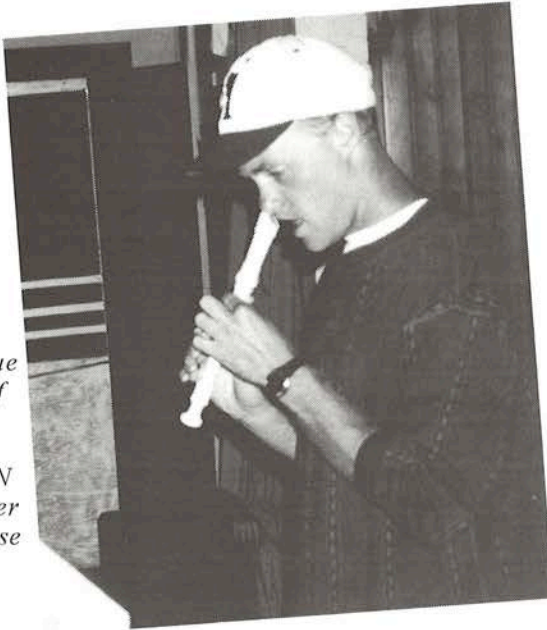

The most unique performance of the night was turned in by MARK CHAPIN and his recorder through the nose recital.



ERIC "PIANO MAN" STANG plays for a packed Wass Hall.

Multi-talented Campers Showcased

JASON "EDDIE" WHITE—

This year's Talent Show was one to remember. The show opened the only way it could with "PIANO MAN", ERIC STANG leading off with a jazzy number to get us in the mood. He was followed by a few card sharks, including SCOTT SCHAFF, JARED RALSKY, MATT KLEIN, and JOSH BENJAMIN. These four gentlemen amazed the audience with quick hands and a smooth style. Other card tricks were performed by RENE HERTSBERG and JAMES McGOVERN. JASON WHITE followed by singing "The Dance" by Garth Brooks. Then CASEY

HINTZ played a Greek Sonata to clam the crowd. The most interesting performance of the night was put on by MATT KAUFMAN who gave a brief display of his stunt man talents. MARK CHAPLIN led the comedy acts by playing "Ode to Joy" on the recorder with his nose. JEREMY EMER and JOSH ZEMEL wowed the crowd with their voice impersonations.

Finishing off a great evening, was the perennial Talent Show star, KOZ, who played Piano Man and Cats in the Cradle.

MEGAPHONE

FINAL SUNDAY EDITION

JULY 31, 1994



Doc's Run '94 Leaves Many Memories

DEAN ANDREW—

"It's hard enough that Toronto has won the last two World Series", yelled race official MARC BEERMANN as Australian DEAN ANDREW passed the race favorite, All-American, Mr. Nice Guy, MARK CHAPIN. For the first four miles of this 4.5 mile race it was neck and neck as the lead changed on many occasions. It was not until the last straight-away, affectionately named "the tunnel", that the Australian could pull away from an illness-recovering CHAPIN.

But the heroes and real characters of the race lay with the other 34 competitors. Conditions as the start for this year's Doc's Run were excellent but the locally trained eye of KOZ did remark that we could all get wet. How right he was.

Drama was set early as one runner never showed, TODD SCHWARTZ had a slight communication (the key word for something?) problem and was still out with his parents (TODD vowed to run it later, which he did).

GLENN started the race, police escort included, and it was a mad dash the first hundred yards as the favorites had to battle with the youthful exuberance of younger competitors.

CHAPIN and ANDREW got a great start and had nervous feelings about dark horses "SLEEPY PINK FLOYD" LLOYD ECKBLAD (Doc's Run's Head of Training) and BRYAN "MEADOWLANDS" WHITFORD.

As the race pushed on some of the events that happened bordered on the comical. EVAN HERMAN realized that he should have "shot a duker" before the race and not during. Heaven knows how much time it cost him, or what he used for toilet paper. People were not at all that keen on giving him a high five at the end of the race, though.

GABE POLSKY mentioned that he probably would have won if he did not have his mid-race regurgitation. GABE soldiered on when many others would not.

The South Of The Border contingent faired well. JOSE VILLA VICENCIO (GOMEZ ADDAMS), tape deck in hand finished fifth, young ANDREW ARAIZA thirteenth, PABLO MAYO seventeenth, MANUEL ESCALANTE twenty-first,

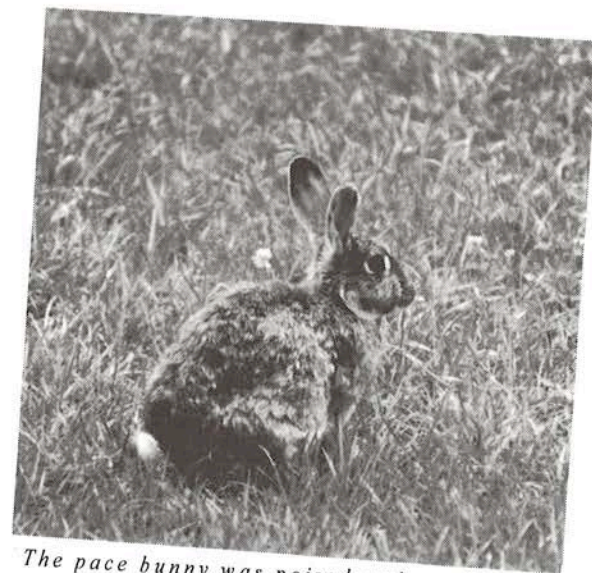

The pace bunny was poised and set the tone at the start of the 1994 Doc's Run



Doc's Run 1994

and ENRIQUE OJEDA (thirtieth) proved yet again what a great acquisition to C.M. our boys from Mexico really are.

Representing the Health Club, we had the only lady runner in the race, CAROL McLAUGHLIN (14th), as well as the highest placed "Doc" ever, Dr. MANSON (7th).

Friendship amongst counselors was present with two ties occurring. One with CARL ROWLAND and ROSS AUSLANDER (both 11th) and ROB EMERY and JOSH "DRY REACH" ROTHENBERG finished in eighth.

Perennial place getter WOODY finished fourth and left behind the races most impressive effort. The highest placed camper in race history was this year's third place getter SIM DARWICK. SIM is having an excellent year at camp and his great form continues. At only 12 years of age, he is a favorite to be the first camper to win this annual event in the near future.

If GABE did not hurl, if EVAN did not duke, if JOSE did not bring his extra luggage, and if MARK CHAPIN did not spend two days in the Health Club only days before the race, the results may have been different. The race winner, DEAN ANDREW in the time of 29 minutes and 22 seconds, congratulated all who raced. Maybe next year the title will make it back to the U.S.A. ...Maybe.



On your marks, get set, "BANG".



*The battle for first,
DEAN ANDREW
and MARK CHAPIN*

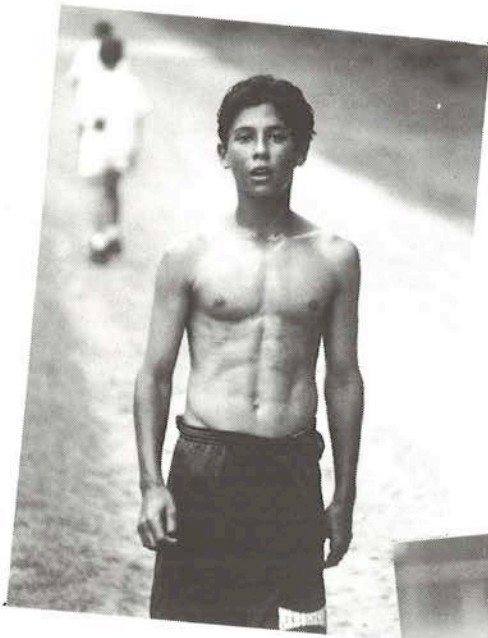

**DOC'S RUN
MEGAPHOTOS**

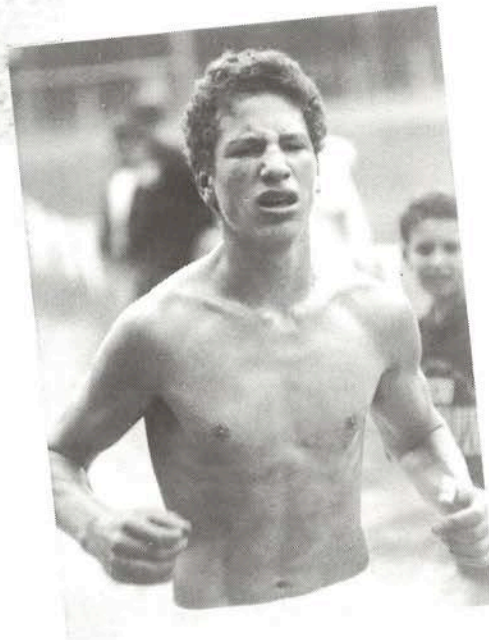

*At the finish,
JOSE VILLAVIECENCIO,
walkman in hand,
GABE POLSKY, and
SIM DARWICK all are winded.*

As the mast of BRETT PESSIS' boat collapses, JOSH HELLER'S boat cruises to victory

Rain-Gutter Regatta Classic



JOPLIN SELL—

Ahoy, Mates! This year's Rain Regatta took place inside the mighty seas of Wasserman Hall on July 31st, 1994. About thirty skippers and crew began making their ships up to three weeks prior to the event.

During many Generals, the walls of the Arts and Crafts room hummed with the sounds of drills, hammers, and saws. With help from JOPLIN SELL and ERIK "LLOYD" ECKBALD, pieces of wood slowly were transformed into many creatively designed ships. As the paint was slapped on and sails were raised, all began to wonder who would be the one to stay afloat and win the race. Some skippers, like AARON EAGLE, MATT GROSS, TODD SCHWARTZ, BRAD BROOK, and JUSTIN JACOBSON decided they would build boats of beauty in hopes of taking home this year's Skipper Award for the best looking boat. Some competitors, like RENE HERTSBERG, JOSH HELLER, JUSTIN CLOUSE, NICK TALBOT, PABLO MAYO, and JAVIER BASAGOITI had their minds set on a different dream; being awarded this year's Speedy Boat Award. As

the day of the Regatta neared, skippers frantically worked on making a boat that would not only rip through the water, but also have the ability to catch the winds of the great Wasserman Hall fan! At around 10:30 a.m., all boats were patiently docked around the two rain gutters that were set up in Wasserman Hall.

The racing began and many boats had difficulty staying right side up, but there were some that took off including BRAD BROOK and JUSTIN JACOBSON'S boat, RENE HERTSBERG's catamaran, and JOSH HELLER'S schooner.

In the finals, BROOK'S and JACOBSON'S Rainbow Swirl Power Cruiser took on KOZ's and BOUTROS' Office Special. Even though the Office Special smoked the Cruiser, KOZ and BOUTROS gladly handed the Championship to BROOK and JACOBSON who took home the Speedy Boat Award. AARON EAGLE was awarded the Skipper Award for the best looking boat and in doing so won a pizza.

A great job was done by everyone involved!

TOWN DAY SATISFIES SHOPPERS

MAV WALTON—

One of the favorite days for both campers and counselors during the summer is Town Day. This year, as usual for Super Camp, the town of Minocqua was the city of choice. At around two o'clock the Menominee buses rolled in and we embarked on our afternoon excursion. We had until 6:30 to explore the shops and eateries and then it was off to see the Minoquabats Ski Show.

Looking around the shops took a long time. MATT HOLLANDER and BRANDON LEVY seemed very taken by the baseball card shop, as were many others. JASON



DAVE LEZAK, DROR NAFTALY, DAVE CHERNER, REED EDWARDS, MIKE MASON, and JOE JACKSON toured the streets of Minocqua for something to buy.

HORN, ELLIOT LIEBERMAN, BRIAN SUMERS, and ADAM WEINGARTEN were not nearly as thrilled by the vegetarian restaurant that NICK OLSON chose for dinner. All was not lost, however, because the others got to eat at the Island Cafe.

Once 6:30 arrived, we all began the short walk through Minocqua in the evening sun. The setting was the beautiful Lake Minocqua. The Minocquabats performed every ski trick we could think of, much to the crowd's delight, including: slalom, barefooting, ballet, and trick skiing amongst others. All too soon nine o'clock was upon us, and we hustled to the buses to make our way back to C.M., tired but satisfied.

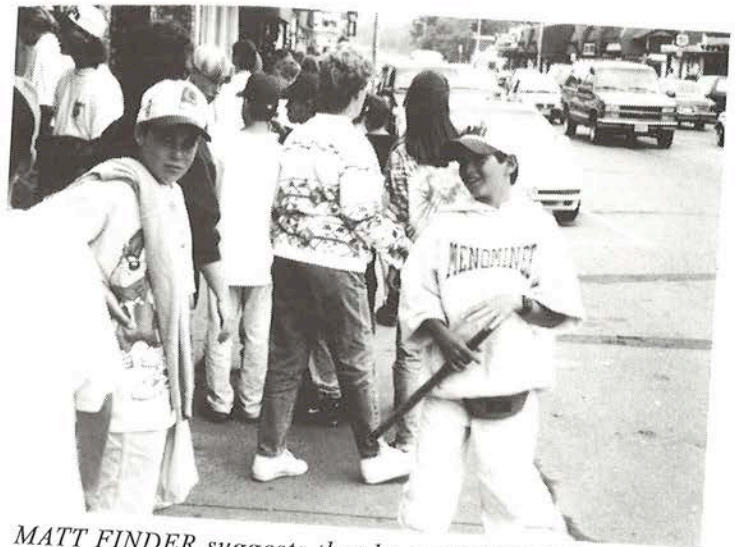

MATT FINDER suggests that he and ETHAN HOROWITZ could use a break after spending all afternoon on their feet.

Camp A Perfect Ten For Boutros, Doc, and Ross



The members of the Decade Club feasted upon Mama's cuisine on 10 Year Night.

Spending ten years of one's life doing anything is certainly significant. This is why Menominee takes the time to recognize those members of its ranks that have been at C.M. for a decade or more. This year saw three new initiates, BRETT GOLDMAN, ROSS ALLEN, and ARI BERNSTEIN enter the Decade Club as well as the following veterans:

DORIS WALKOWSKI	28 YEARS
GLENN KLEIN	26 YEARS
DENNIS KOSLOSKI	22 YEARS
MARC BEERMANN	14 YEARS
DAWN KLEIN	13 YEARS
JEANNE NYHOLM	11 YEARS



The new inductees into the Decade Club enjoyed a filling dinner at Mama's in Minocqua, the beautiful Decade Club Sweaters, as well as some fond memories.

The Stanley Cup? No, The Steve Ehrlich Trophy



Directly following the Decade Club ceremony, there was a major event of C.M. '94. The dedication of the Senior Twi-Light League Trophy took place. The Trophy will from this year on be known as the STEVE EHRLICH Senior Twi-Light League Trophy in acknowledgment of STEVE'S dedication and love for Menominee over the past 35 years. STEVE is not only the father of Cabin 10's PETER EHRLICH, but is also the coordinator/ director of C.M.'s Fantasy and Post Camps. STEVE was in Camp visiting PETE and catching some large northern out of Sand Lake.



STEVE EHRLICH and his trophy

MEGAPHONE

MENOMINEE-KAWAGA RESUMESTRADITION EDITION

AUGUST 1, 1994



11A Upholds Softball Tradition vs. Kawaga

CORY PROVUS—

As the 11A softball team took the field in no way were they intimidated by the swampy atmosphere of Camp Kawaga. From the beginning, coaches BEERS, NATE, and C.P. knew that hitting would be the key. Through the first few innings, the captain of the team, MIKE WEINER showed his experience and patience by pitching a no hitter all the way to the fifth inning. But then, Kawaga struck with a run in the fifth.

Menominee did not get down, they just got back. Leading off the sixth for Menominee was JOSH HELLER who hit a shot to third, and by hustling it out he was able to beat the throw.

Then came BRETT RHEINGRUBER. RHEINGRUBER hit a bullet into left advancing HELLER to third. Then came the

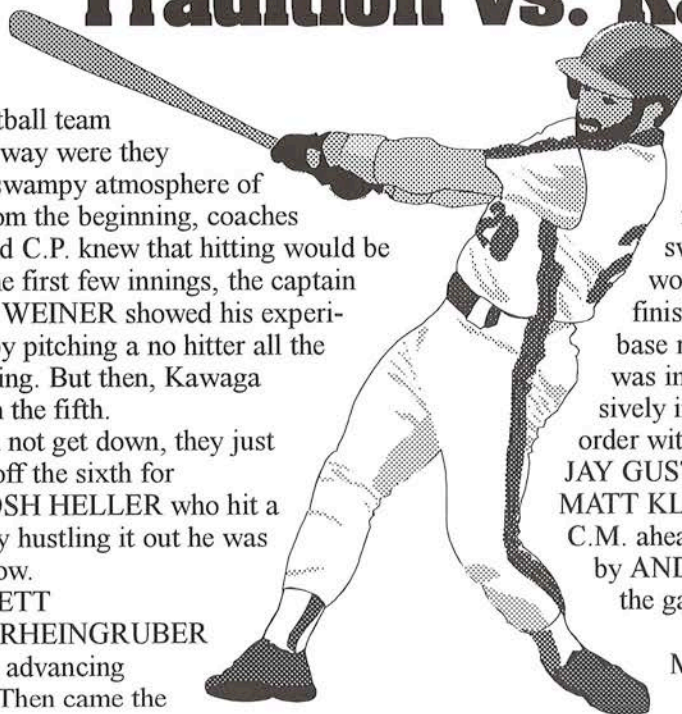

big man, MATT "BERCO" BERCOVITZ. He took the first pitch for a called strike. Then MATT was ready to swing. WHACK! A drive into right center that scored HELLER easily from third, GOOBER rounded second, got the swinging arm around third and scored on what would be a triple for BERCO. Menominee was not finished yet as SCOOTER GOLDNER nailed a base rap to score BERCO from third. Menominee was in the lead 3-1. Menominee stepped up defensively in the bottom of the sixth, retiring the side in order with great defensive play by SKIPPY ROSEN and JAY GUSTAFSON. In the seventh, ERIC ISRAEL and MATT KLEIN combined to produce another run, putting C.M. ahead 4-1. With another solid defensive inning, led by ANDREW DRAFT in right, Menominee finished the game on a MIKE WEINER strike out.

Menominee's 11A showed Kawaga that Menominee Softball is indeed number 1.

Just Short Of Perfection 16A Nipped At Kawaga

STEW AUSLANDER—

It was a hot, sun-scorched afternoon at Camp Kawaga. As the highly confident 16A softball squad stepped to the plate they were met by a pumped up team from Kawaga. As usual, Menominee's defense was stellar.

Throughout the game, ALAN TRUBOW, ANDY SCHIMEL, STEWART AUSLANDER, GREG ABRAMS, and BOBBY GOODMAN laid it all out on the field to help pitcher ARI ROSEN contain the explosive hitting of Kawaga to six total runs. Going into the game

we knew we would need to produce at the bat. Despite knowing this we did not hit the ball where they weren't. For the first two innings we were stopped in order. In the third inning CORY PROVUS led off with a walk. He was followed by a ground out by GOODMAN advancing PROVUS to second, a single by ROSEN and fielder's choice by STEW AUSLANDER got our first run in. The next inning ROSS AUSLANDER hit a two run homer into the right field swamp to grab the lead 3-1. In the fifth

Continued on next page...

Just Short Of Perfection continued...

inning with the score 3-3, pinch hitter STEVE KATZ led off with a single, followed up by a single from GOODMAN. With one out, STEW AUSLANDER doubled scoring two runs to retake the lead for Menominee 5-4.

Going into the top of the seventh, the Eagles found themselves down 6-5. STEVE KATZ led off the inning with a line drive out to Kawaga's short stop. GOODMAN then lined out to the third baseman. Two out. JEFF DAVIDSON

then walked bringing up STEW "NATE" AUSLANDER. The crowd cheered him on, but it was not enough as he grounded out to end the game. Despite the valiant efforts of the 16A to go undefeated, they lost 6-5. Even though JASON "BEAR" SCHWARTZ and PHIL STREHNELL did not get to play, they were constantly cheering our team on trying to help us to victory. While no team is perfect, this years 16A very nearly was.

13A HOOPS TROUNCE KAWAGA

MARK CHAPIN—

The 13A basketball team walked on the court Monday, prepared for battle against a tough Kawaga team. However, Monominee would run away with a 63 to 37 victory in impressive fashion.

COLIN TAHI was the dominant player in the first half pouring in 18 points and controlling the rebounds.

BRIAN ANDLAMMAN was the general; leading the show and taking care of the ball. His defense was just as impressive as he applied full court pressure throughout the game and came up with some huge steals. Others adding to the victory were: starters TODD RHEINGRUBER who dominated the boards with TAHI, CRAIG RASHKOW who scored some key points in the first half and JON JAPHA made his presence felt on defense as the Soaring Eagles applied a tough full court press which was the difference in the game.

Players coming off the bench and making a definite impact were MATT "CHICO" WEISS who pumped in an impressive ten points and who had four steals. SIM DARWICK applied intense pressure on defense, and finally JAKE GOLDNER who poured in some key baskets.

Overall, it was a FANTASTIC win for the Eagles. *Great Job Guys!* Thanks for the superb effort, signed Coach Chaps.

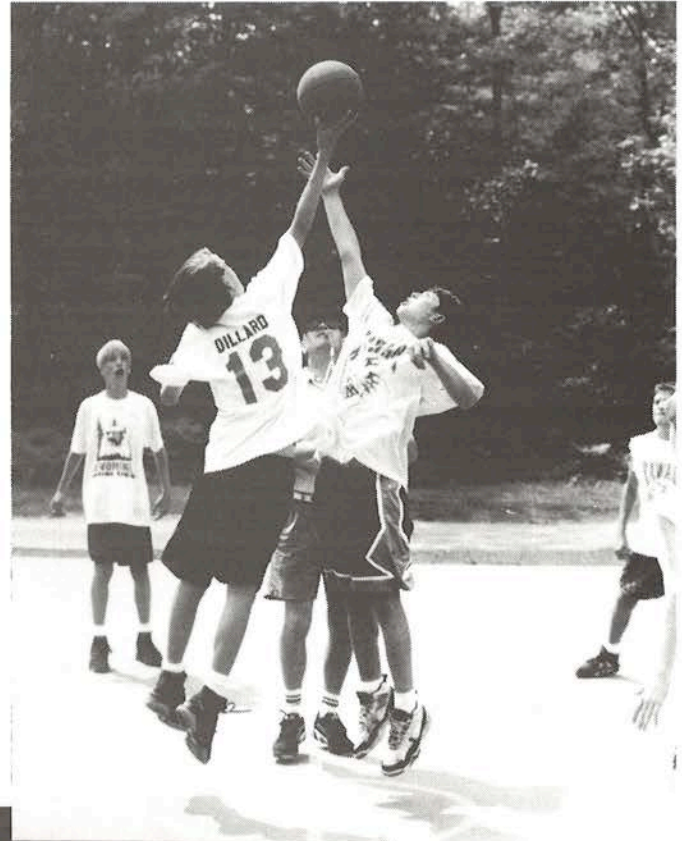

^ COLIN TAHI wins the opening tip

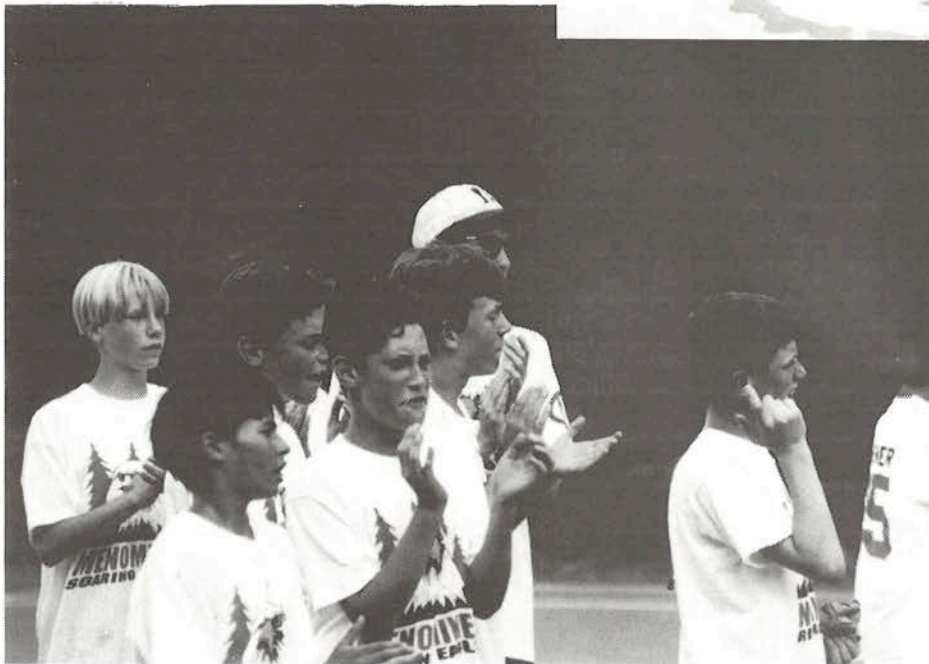

< 13A gives a cheer at the end of their win

PSYCHED-UP 13B HOSTS KAWAGA

JON KULESZA—

Boy oh boy! Fired up could not even come close to describing the way the boys were at the start of this grueling game against Kawaga. Defense and rebounding were the name of the game today and JORDAN GOLDFARB provided plenty of it. He blocked shots, he scored and most importantly he was our best rebounder.

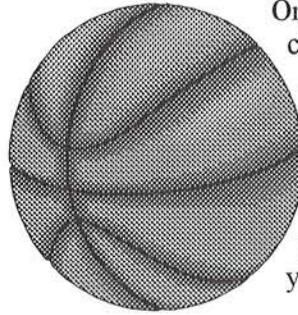

On defense we had a trio of guys who put the clamps on their two top players, especially in the second half. JOHNNY SCHATZ, SETH RHEINGRUBER, and BRETT CHETEK went all out. Nice work fellas. Unfortunately in the end we came up short by 13 points. I applaud your efforts and your willingness to keep your head in the game, ALEX YUSPEH, kudos to you!!



Another Nailbiting Win For 13B

JON KULESZA—

For the second straight game the 13B softballers had to come from behind. In the first inning we fell to a 4-2 deficit. Offense early on was provided by DANNY LEVY, OREN JACOBSON, and BRYAN SIMKIN. After Kawaga began to pull away, our comeback came into sight. In the bottom of the third, down four runs, SIMKIN and TODD BLOCK both singled leaving the door open for TED "SWEETY BABY" ROTH who drove in both guys with a triple. TED scored later on a fielders choice to pull within one. We then

came back in the bottom of the fourth to tie up the score at seven. The stage was set. After clawing and scratching all game to stay within striking distance we had our chance in the bottom of the seventh. With one out and a man on first and second, ALEX YUSPEH came to bat. The pitch, then a line shot to right field to score TED ROTH from second - the winning run!! A perfect ending to a great, well played game. You guys were a pleasure to coach. GREAT WIN GUYS!!

13A Tripped-Up

BRETT "BOUTROS BOUTROS" GOLDMAN—

For six innings it was anybody's ball game. The 13A took on Kawaga for the first time in two years and showed heart. In the third inning BRIAN ANDLAMAN led off with a double and later scored on COLIN TAHI'S single. But the inning was soon ended on a highly controversial call at the plate. After the momentum was killed, Menominee's bats quieted considerably. JON JAPHA, SIM DARWICK, and

PETER BERNICK played solid "D" in the infield while JAKE GOLDNER, JOHNNY SCHATZ, BRIAN ANDALMAN, and BRETT CHETEK patrolled the outfield. The battery of SETH RHEINGRUBER and JORDAN GOLDFARB was tough through six but Kawaga's bats came alive in the seventh as they exploded for 11 runs.

The boys played tough and I for one was very proud to say I was their coach.

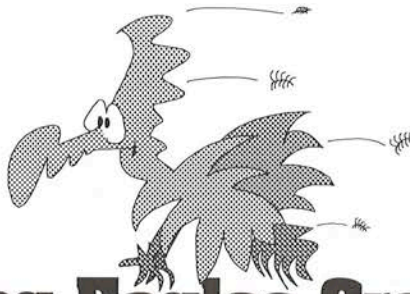

IIB Soaring Eagles Grounded

FRANK JOHNSON—

The team was ready to renew the intense rivalry against Kawaga. Kawaga got three runs in the bottom of the first and the Soaring Eagles were down 3-0 just like that. However, Menominee bounced back with two runs thanks to consecutive singles by MARTY WEISMAN, MIKE HERTZ, and JON WALTON that loaded the bases and then SAM YUSPEH singled to score WEISMAN and RBI

ground out by JOSH ZEMEL scored HERTZ. The middle three innings found Kawaga scoring one run to push their lead to 4-2, as BRETT RHEINGRUBER pitched beautifully. Menominee threatened in the fifth as they loaded the bases from walks issued to MATT HOLLANDER, JOSH KURZMAN, and single by JOSH ZEMEL with one out. However, the Eagles failed to score and Kawaga went on to win by a final score of 6-2.

16A HOOPS IMPROVES

“H”—

When the Soaring Eagles traveled to Kawaga, we knew we had our hands full as the week before Kawaga edged us in victory. Now was had to go to their court and try and come out with a victory. CM started with REID BARTHA at point, and ARI ROSEN (also known as ARI ROSEN) at off guard. In the front court was ANDY (SLINKY) SCHIMEL, ALAN (BONER) TRUBOW, and JASON (THE BEAR) SCHWARTZ. With this combination and a tough 2-3 zone we felt we had a great chance of slowing

down Kawaga's excellent fast break attack. We did just that. CM was down eight points at the half, and things were looking very promising. Off the bench came AARON (SOARING) EAGLE, MATT PASSEN, and STEVE KATZ. Again Kawaga did prove to be stronger as they increased the lead to seventeen as the game came to a close. Menominee was very proud of this game, however, as the score was **much** closer that the previous game played.

All players commented after the game, “We played as hard as we could and we have no regrets!”

SCHAFF'S CLUTCH FREETHROWING SOARS EAGLES OVER KAWAGA

“H”—

On Monday, our 11A took on Kawaga in several events. The most exciting, and climatic was the 11A basketball game. It seemed like we had been in this position before, as we were faced by a bigger team that was cocky and sure of themselves. However, our quick Soaring Eagles led by MATTY KLEIN and SCOTTY SCHAFF knew what it would take to win - hard consistent play! Also, the team talked with coach “H” before the game about keeping it close and putting ourselves in a good position to win the game.

Other starters included: BRETT REHEINGRUBER, JARRET TURBIN, and in the middle, ELI PLATT. Key elements off the bench were: DANIEL ROSEN, MICHAEL WEINER, ADAM WEINGARTEN, JON WALTON, and JOSH BENJAMIN.

The game was close the whole way as Menominee was scrapping for loose balls and leaving themselves down on the court. At the end of the game CM found themselves down two points when SCOTTY SCHAFF hit a baseline jumper. With the score tied, Kawaga had one last chance to

take the lead as they had the ball with ten seconds remaining. CM then made a great defensive stop and called a quick time out. Whit four seconds remaining the Eagles ran a play for SCOTTY SCHAFF to catch the ball at half court and drive to the basket. SCHAFF got fouled on the play and went to the line shooting two with no time remaining in the game. All he had to do was make one free throw, and the game was ours. The first shot rimmed around and out. The second went straight in for the game winner!! The excitement level climbed as all of the spectators rushed the court at Kawaga. It was the second time this summer a SCHAFF freethrow had won C.M. a game, and it was great to go into someone elses house and come out with the “W”!

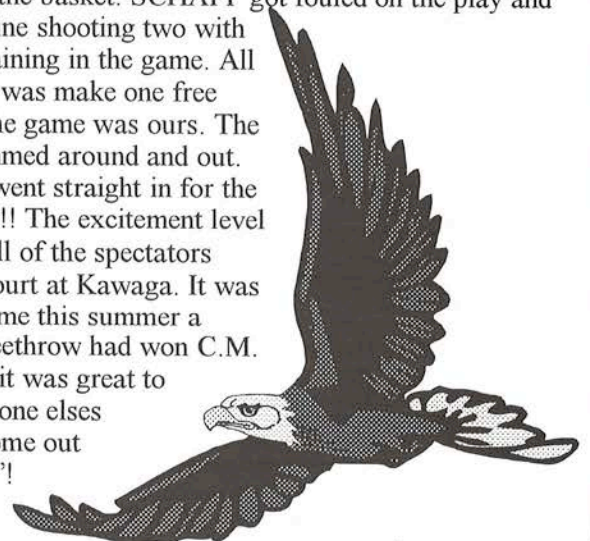



MEGAPHONE

TOURNEY TIME EDITION

AUGUST 2, 1994



MCAA Championship Playoffs

MLB

Eastern Division World Series

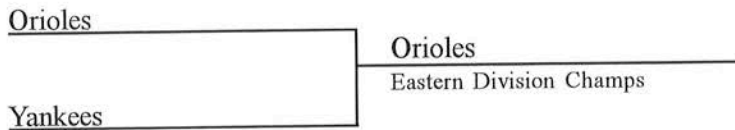

Central Division Playoffs

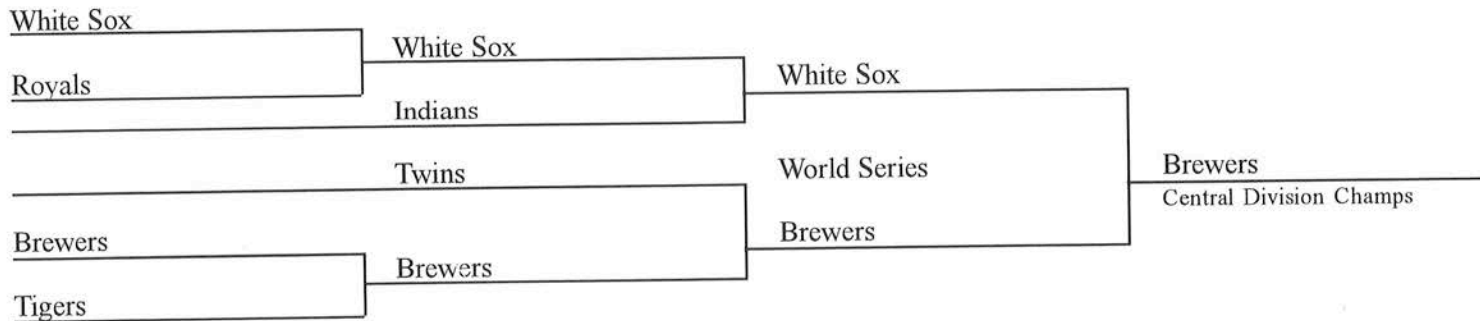

Western Division Playoffs

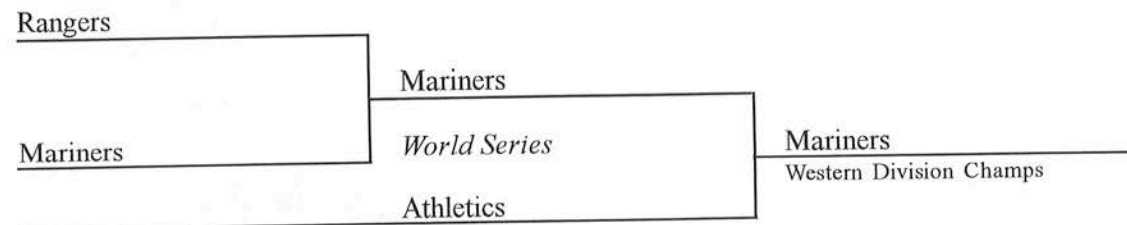

MCAA Championship Playoffs

MBA

Eastern Division Playoffs

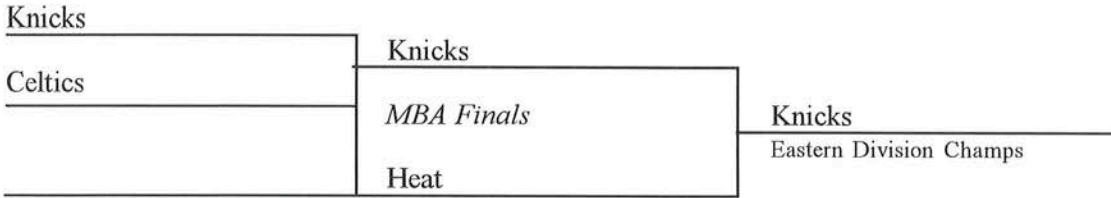

Central Division Playoffs

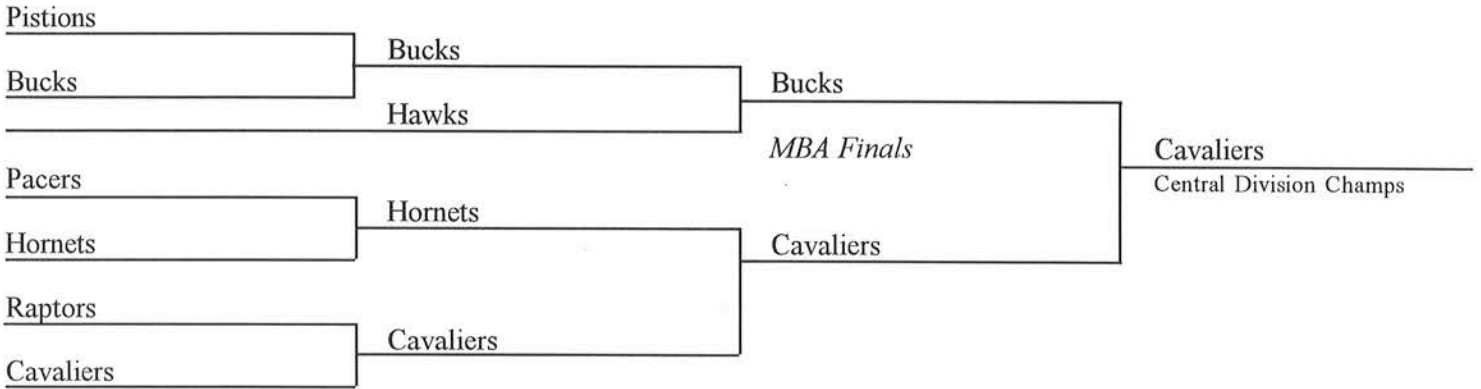

Midwestern Division Playoffs

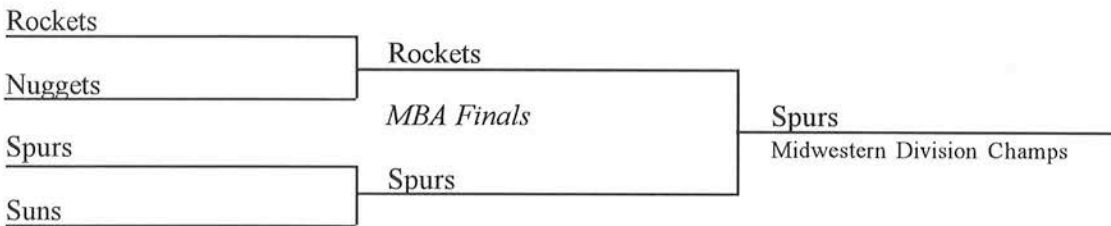

Western Division Playoffs

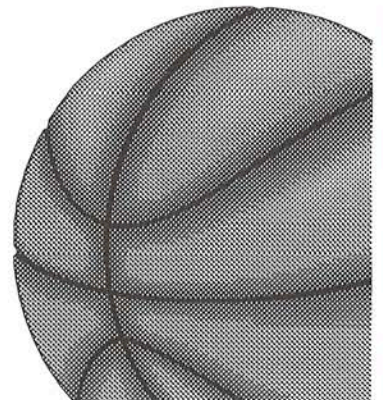
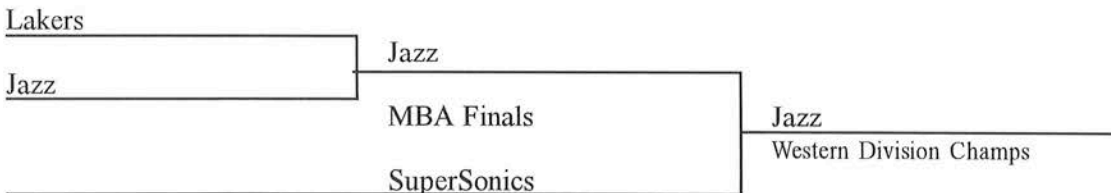

MCAA Championship Playoffs

MHL

Smythe Division Playoffs

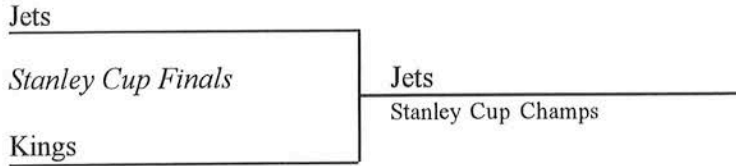

Norris Division Stanley Cup Playoffs

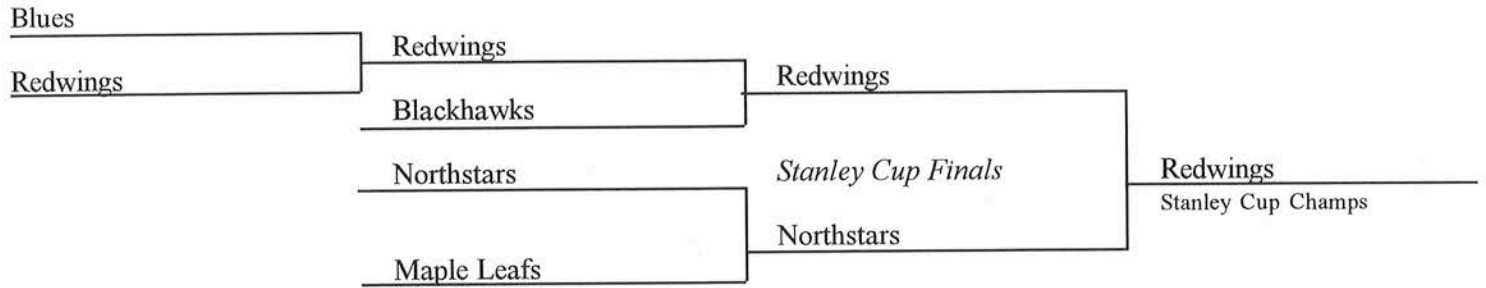

Patrick Division Stanley Cup Playoffs

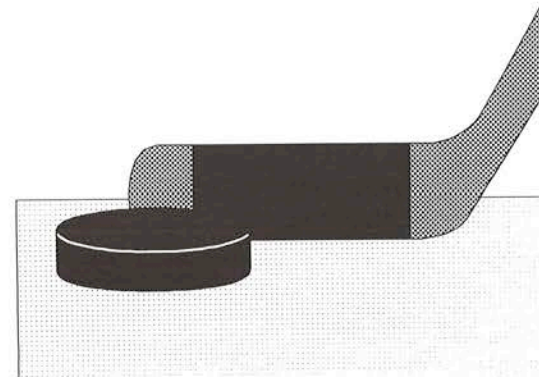
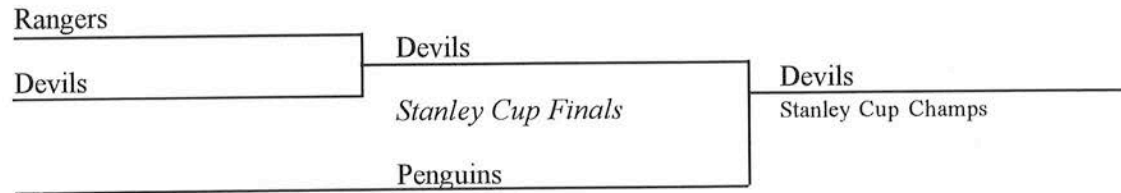

MCAA Championship Playoffs

MISL

Division 1 World Cup

Lazio

World Cup Finals

Arsenal

Arsenal

Division 1 World Cup Champs

Division 2 World Cup

Liverpool

Glasgow Rangers

Real Madrid

FC Jerusalem

Liverpool

World cup Finals

Real Madrid

Liverpool

Division 2 World Cup Champs

Division 3 World Cup

AC Milan

Sampdoria

Sampdoria

World Cup Finals

Manchester United

Manchester United

Division 3 World Cup Champs



MCAA Championship Scoresheet

The conclusion of the 1994 MCAA season provided some of the most memorable games of the summer. The commissioners that organized the fantastic seasons were: BARRY QUAYLE (MBA), FRANK JOHNSON (MLB), BRYAN WHITFORD (MHL), CRAIG ZIPPERER (MISL), TONE TURNER (Tennis), MARK CHAPIN and BRYAN WHITFORD (Track), JON KULESZA (Volleyball), MAV WALTON (Swimming), ANDREW PINGER (Archery), and DROR NAFTALY (Riflery). Much debt is also owed to KOZ who put together the Tournaments.*

As was promised early in the season, every league of the MCAA was intense and loaded with great games. The Championship Tournaments continued right on pace. Here are the game summaries and tournament highlights:



MBA Championships: First Round Scoreboard

Eastern Division

Knicks	21
Celtics	17 F

Central Division

Pistons	36
Bucks	41 F

RYAN HOLZ put in 22 for the Bucks in their win.

Pacers	34
Hornets	43 F

Raptors	22
Cavs	24 F

SIM DARWICK and MIKE WEINER combined for 20 points to lead Cavs to a "W"

Midwestern Division

Rockets	37
Nuggets	30 F

ROSS SIDER sunk 15; SCHATZ and GOLDFARB scored a combined 20 for victorious Rockets.

Spurs	25
Suns	19 F

RONJON DATTA nailed two 3's; COLIN TAHI dominated inside 14 points with 12 rebounds for the Spurs.

Western Division

Lakers	57
Jazz	63 F

REID BARTHA scored 18, JEFF HOOD 14, and ANDY SCHIMEL 14 for the Jazz.

BOBBY GOODMAN hit four from downtown for the Lakers in a losing cause, winding up with 20 points.

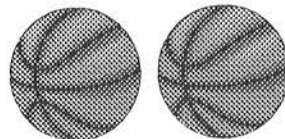

Second Round Scoreboard

Central Division

Bucks	32
Hawks	25 F

HOLZ poured in another 18, BRETT RHEINGRUBER chipped in with 8 to put the bucks on top and in the MBA Finals.

Hornets	14
Cavs	38 F

MIKE WEINER led the offensive attack for the Cavs scoring 24, as the Cavs took the Hornets.



The MBA Finals:

Eastern Division

Knicks	17
Heat	14 F

The Knicks finished off a perfect season, losing no games. ERIC ISRAEL dominated down low in this game, scoring five and corraling 13 rebounds. JUSTIN HOROWITZ led all scorers with 9. Coach BARRY QUAYLE led his team to victory for the second straight year, as the Knicks took the MBA Championship in the Eastern Division for 1994.

Central Division

Bucks	23
Cavs	24 F

The game remained close until late in the second half when MARK CHAPIN coached his team into a six point lead over the Bucks. But, the Bucks quickly closed the gap, and the game was tied with 40 seconds remaining. With five seconds remaining, SIM DARWICK hit a clutch free throw to put the Cavs on top for good, 24 to 23.

Notables: MIKE WEINER once again led the Cavs offense

with 15, DARWICK scored 10 including two from downtown. RYAN HOLZ was a key in keeping the Bucks in the game, scoring 14. The Cavs are the MBA Central Division Champs in '94.



REID BARTHA and AARON EAGLE jump it up in the MBA Western Division Playoffs.

Midwestern Division

Rockets	43
Spurs	40 F

In a game that would prove to have one of the greatest finishes in MBA history, the Rockets defeated the Spurs for the MBA Midwestern Division Championship. With the game tied at 40 with less than two seconds remaining, PHILIPPE IFERGAN passed the ball to ANDREW BENDER on a last ditch effort to win. BENDER put up a three and nailed it from near half-court. The Rockets stormed the court as the Spurs looked on in disbelief. Great games were played by ROSS SIDER for the Rockets and COLIN TAHI and Mr. Clutch himself, ANDREW BENDER for the Spurs.

Western Division

Jazz	64
Sonics	55 F

A beautiful day for basketball presented itself for the Jazz to take on the Sonics for the MBA Western Division Championship. Led by REID BARTHA and his 24 points, the Jazz controlled the tempo of the game, and BRIAN

ANDALMAN said "kaboom" four times from three point land and scored 18 while providing outstanding hustle up and down the court. GABE POLSKY put in 22 for the Sonics, but it was just not enough as the Jazz took the Western Division MBA Championship for 1994.

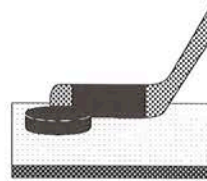

MHL Stanley Cup Playoffs: First Round Scoreboard

Norris Division

Blues	2
Redwings	9 F

Scoring: For the Redwings - MARTY WEISMAN and BRAD MENDEL both had hat tricks, JOEL SORINSKY 2, PETER EHRlich 1, For the Blues - BRETT CHETEK 1, JEREMY GLAZMAN 1. SIM DARWICK sparkled in goal for the Redwings as he allowed only two goals.

Patrick Division

Rangers	2
Redwings	4 F

MATT PASSEN of the Rangers scored two unassisted in the first period of play. The Devils came storming back however, scoring four unanswered goals: two by GABE POLSKY and one each for TED ROTH and PHIL STERNHELL.



MATT PASSEN'S offensive firepower was Key in the Ranger attack.

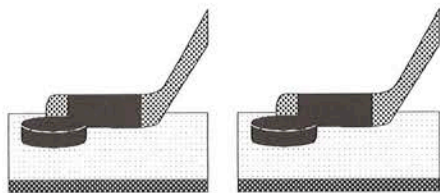

Second Round Scoreboard

Norris Division

Redwings	7
Blackhawks	0 F

MARTY WEISMAN gets the hat trick, supported by PETER EHRLICH who scored twice and BRAD MENDEL and JOEL SORINSKY who each scored once. SIM DARWICK left the rink allowing no goals.

Stars	4
Leafs	2 F

JOSH KURZMAN scores two for the Stars as they defeat the Leafs to go into the Norris Division Stanley Cup Finals. OREN JACOBSON made some fantastic saves in goal for the Stars and shut out the Leafs in the third period.

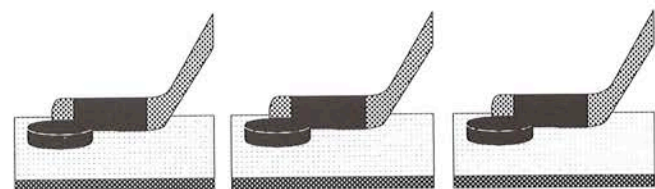

Stanley Cup Finals

Smythe Division Finals

Jets	4
Kings	3 F

ANDREW DRAFT led the Jets to victory with his hat trick. JOSH ZEMEL chipped in with the game winning goal in the third, while JUSTIN HOROWITZ clinched the win for the JETS in goal. For the Kings, JEREMY EMER, ERIC ISRAEL and HARRIS KEALEY each had a goal and an assist, but it was not enough as the Jets became the first ever Smythe Division Stanley Cup Champs.

Patrick Division Final

Devils	6
Penguins	5 F

Coming into the Patrick Division Playoffs, it appeared that the Rangers would run away with the Championship. But, the Devils, led by GABE POLSKY and the Penguins, led by JEFF DAVIDSON proved to be more up to the challenge. In the Final, the Devils jumped out to an early lead, sparked by GABE POLSKY. However, the Penguins remained tough, and came back with the help of a hat trick by JEFF DAVIDSON and two goals from MATT COHEN. However, a hat trick by POLSKY, two scores from TED ROTH, and one from PHIL STERNHELL put the Devils on

top 6-5 late into the third when JEFF DAVIDSON had a breakaway opportunity with thirty seconds remaining. Devil's goal tender, JOSH MERSFELDER, saved the day, denying DAVIDSON of his potential game tying goal. MERSFELDER made the save of the game to put the Devils on top of the 1994 MHL Patrick Division for keeps.



MLB World Series:

Eastern Division

The first of the World Series match-ups in the MLB pitted the Orioles versus the Yankees from the Eastern Division, in an offensive slug-fest. In the top of the first, the Yank's JEREMY EMER crushed a two run home run to give the Pinstripers an early 3-0 lead. However, in the bottom of the second, the O's countered with nine runs. ERIC STANG lead off the inning with a homer, which started the onslaught. JOE and JUDAH KLEIN followed with singles and later scored on a two RBI triple by HARRIS KEALEY. ANDREW DRAFT added a two RBI double and JUDAH KLEIN rounded out the nine-run second by stroking an RBI single.

The Yank's MIKE REICH added an RBI triple and two run home run later in the game, and when ANDY MANSON'S single scored BRANDON DAVIS the Yank's took the lead 11-10. But, the Oriole's ANDREW DRAFT and JOSH ZEMEL added RBI hits and JOE KLEIN'S two Single in their half of the fourth inning put the O's on top for good. The Yank's last chance proved to be a gallant effort. JOSH HELLER'S two run triple cut the lead to 2, and it looked like the Yank's might come back all the way. However, that's where the score finished, and the O's took the Eastern Division World Series by the final score of 16-14.



ERIC ISRAEL keeps his eye on the ball at the plate during the Eastern Division World Series.

Western Division

The World Series in the Western Division saw the A's take on the Mariners. The game was billed to be an offensive struggle, and that's exactly what it turned out to be. In the top of the first, JOE ROSENBAUM and ANDY SCHIMMEL singled and AARON EAGLE'S sacrifice fly gave the A's an early 1-0 lead. The Mariners threatened in the bottom of the inning when ZACK WEINER singled and JON JAPHA doubled. But, they failed to score until their final at bats when JEREMY FRYDMAN lifted a towering home run over the left field fence of new Al Lewis Field. Then, JORDAN GOLDFARB singled, advanced to third on an error, and scored the winning run on TED ROTH'S base hit to right, which gave the Mariners a 2-1 win and the Western Division Crown.

Central Division

The six team Central Division provided a group of playoff games that provided plays and games for the record books and highlight films for years to come. The two first round games featured the Brewers versus the Tigers, and the White Sox versus the Royals. In the first game, the Brewer's DOUG LEVIN had a two run double to lead the Brew Crew past the Tiger's by a final score of 3-2. In the second game the White Sox versus Royals, the combination of SIM DARWICK and JEFF HERTZ of White Sox proved to be too much for the Royals. HERTZ had two RBI double in the first, scoring DARWICK and ANDY SLUSSER. The Royals put up a good fight, however, SCOTT SCHAFF and JOEL SORINSKY had run scoring hits for the Royals to cut the lead to 3-2. DARWICK then added a homer and JORDAN GAULE and JEFF DAVIDSON added RBI singles to make the final score 7-4 in favor of the White Sox.

In the second round, the White Sox took on the Indians and the Brewers played the Twins. PETER BERNICK of the Brewers hit a three run homer and JERMEY GLAZMAN added his own three run blast which made it look like the Brewers were well on their way to an easy win. They led 8-0, but the Twins began to claw their way back. BRAD ROSS and ADAM GREENBERG had two hits and two runs scored each for the Twins. However, when MATT FINDER of the Brewers hit a solo home run and MIKE HERTZ added an RBI triple, it proved to be too much for the Twins who fell to the Brewers by a final count of 11-6.

The Brewers would face the Sox in the Finals, after the Sox won the most exciting game of the season. The Sox won 11-10 after being down 8-3 going into their last at-bats. They tied the score at eight to send the game into extra innings. Even though they fell behind again, 10-8, in extra innings they came back once more, this time to win the game outright. MIKE WEINER, ELI PLATT, RYAN HOLZ, and BRAD MENDEL were all instrumental in giving the Indians what seemed to be an insurmountable 8-3 led. The White Sox were losing 8-4 with two outs when JORDAN GAULE hit a two run home run to cut the deficit to two. DAN ROSEN then singled and JEFF HERTZ double to set the stage for SIM DARWICK. He cracked a

double to tie the game at eight. The White Sox then found themselves down 10-8 in extra innings. JORDAN GAULE came through in the clutch once more, hitting a two run homer to tie the score at ten. ROSEN then tripled and when HERTZ lined a single to left, the comeback was complete and the Sox had won the right to take on the Brewers in the Finals.

The final game of the Central Division Playoffs was filled with excitement and great anticipation as the White Sox hoped not to have a let down after their emotional win over the Indians. The Sox jumped on the board first as SIM DARWICK hit a two out triple, and JEFF HERTZ singled him in. ANDY SLUSSER then singled, followed by an RBI double by JEFF DAVIDSON. The White Sox were up 2-0.

In the second, the Sox added two more runs on a two run triple by JEFF HERTZ. However, in the bottom of the third, the Brew Crew exploded for seven runs to take a 7-4 lead. Highlights from the rally included RBI singles by PETE BERNICK, MIKE HERTZ, BRIAN SUMERS, MATT FINDER, JARRET TURBIN, and a two run single by BERNICK. Going into the last inning, the Brewers led 8-4. After SIM DARWICK'S single scored JORDAN GAULE, the score was 8-6, and that is where the White Sox comeback threat ended. The Brewers captured the Championship by beating the Sox 8-6.

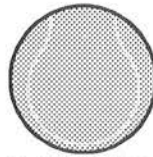

MTP Is A "Classic"

TONE—

This year's MCAA Tennis Tournament was a huge "Ace". The massive sign-up, over 140 campers, made the MTP Classic have the highest percentage of campers involved of any sport having an MCAA Tournament.

In the Junior singles matches, JUSTIN "SPUD" HOROWITZ came through an incredible match against JOSH HELLER to win in a tie-breaker, 7-6. In the Intermediate doubles, favorites OREN JACOBSON and JOEL



A highlight of the year's MCAA Tennis Tournament was the great turn out.

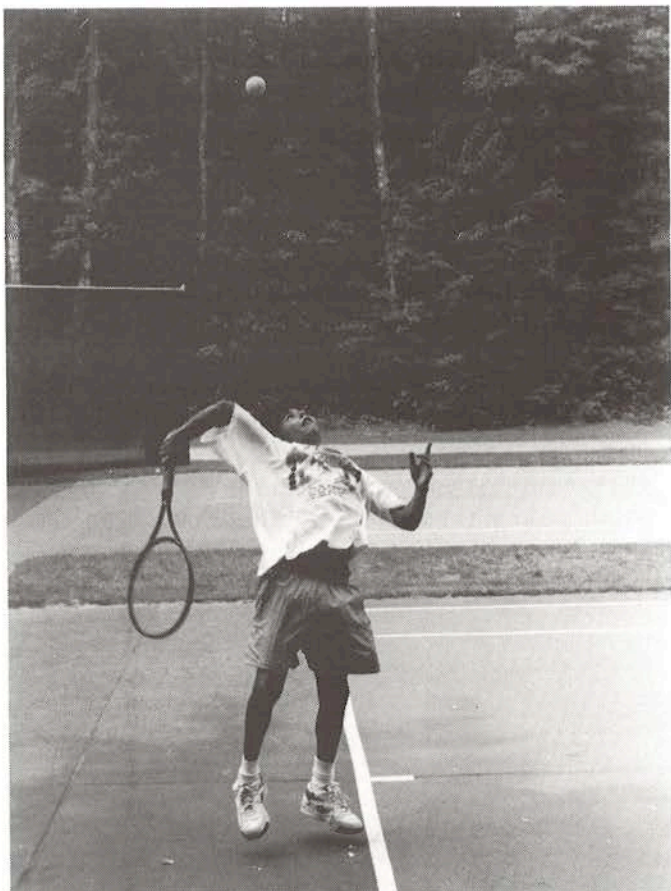

SIM DARWICK prepares to smash a serve.

SORINSKY played very well through all four rounds of competition to take a 6-4 win in the final. The Intermediate singles Tournament featured some fantastic matches on the way to a SIM DARWICK versus MIKE WEINER final.

All of the matches were played with high intensity while at the same time all competitors showed good sportsmanship. The whole tournament was a great success, and the kids had a wonderful time.

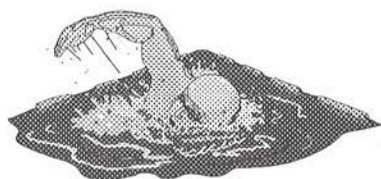

MCAA Swimmers Near Record Times

MAV WALTON—

The 1994 MCAA Swim Meet was attended by some of Menominee's best swimmers. Among the eleven swimmers that participated were: MIKE SOLOVY, PETER EHRLICH, JOSE BASAGOITI, JAVIER BASAGOITI, ANDRES ARAIZA, and JEFF HOOD.

All of the competitors showed up on the shores of Sand

Lake to try their best to beat the best. First up was the freestyle competition. Respectable times were rendered by all, but the top speeds for each age division belonged to: HARRIS KEALEY, (19.17 seconds), MIKE SOLOVY (13.32 seconds), and JEFF HOOD (11.29 seconds).

Next up was the breast stroke. The three winners were: JOSE BASAGOITI (17.41 seconds), HARRIS KEALEY (21.94 seconds), and JEFF HOOD (17.07 seconds).

Other notable times in the back stroke and butterfly events were made by JAVIER BASAGOITI (18.78 seconds in the backstroke) and JAKE GOLDNER (17.83 seconds in the backstroke).

JOSE BASAGOITI, PETER EHRLICH, JAVIER BASAGOITI, and MIKE SOLOVY all made a heroic effort to beat the long standing medley record of 1.02.29. However, their best time was just barely more.

No Menominee records were broken that day, but we can conclude that perhaps a few personal ones were.

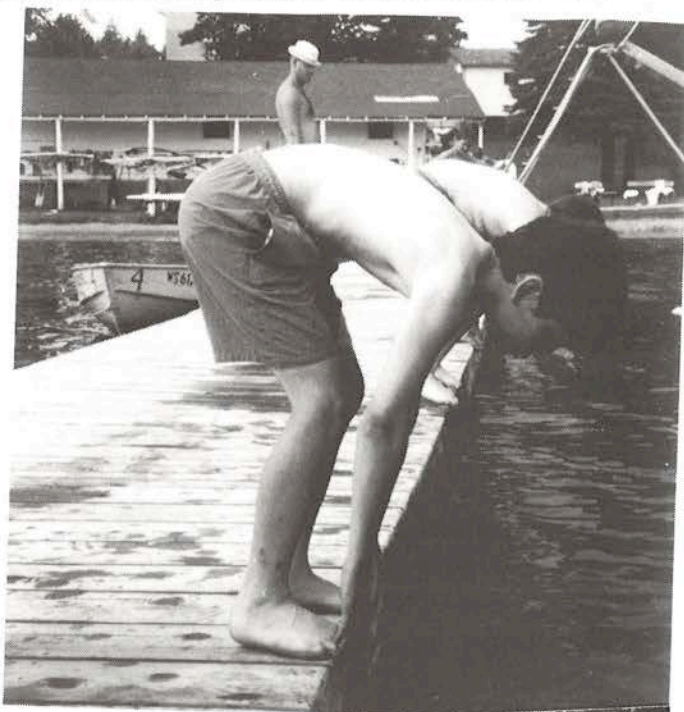

> JAVIER
BASAGOITI and
ELLIOT
LIEBERMAN
prepare to dive into
Sand Lake for the
MCAA Swim Meet.



MCAA
ARCHERY
COMPETITION
HIGHLY
COMPETITIVE

BRAD MENDEL—

With over forty participants in this year's MCAA Archery Competition. Even though archery is an individual sport, the day's competition provided to be cut-throat. The Junior Division had a strong showing with over a dozen challengers. JAMES McGOVERN, who was favored to



DAVE LEZAK takes aim during the MCAA Archery Competition.

win, showed every bit of his skill to win with a score of 86. Dark horse JUSTIN CLOUSE rocketed forward from the semiskilled masses to make his mark at second place. Third

place was wrapped up by rookie sensation, ANDREW DRAFT.

The Intermediates were no less competitive. BRAD MENDEL, who did not shoot in a single competition this summer, had a breakthrough performance and scored high enough to place third. Second place was taken by RENE HERTSBERG who scored an incredible 91. First place was left to Iowa City resident, COLIN WEINER. From the rather unfamiliar twenty yard line, COLIN managed to fire an overwhelming 96 to take top honors.

Finally, the Senior Division took to the range. Competitors came in search of the highly esteemed first place award for the Competition. Third place was earned by crowd favorite EVAN ROSENBERG who shot a 92. RICKY KIRSCH and BRYAN SIMKIN both shot 96's, leaving a tie. A tie breaker was based upon previous inter-camp competition, and SIMKIN took home first.

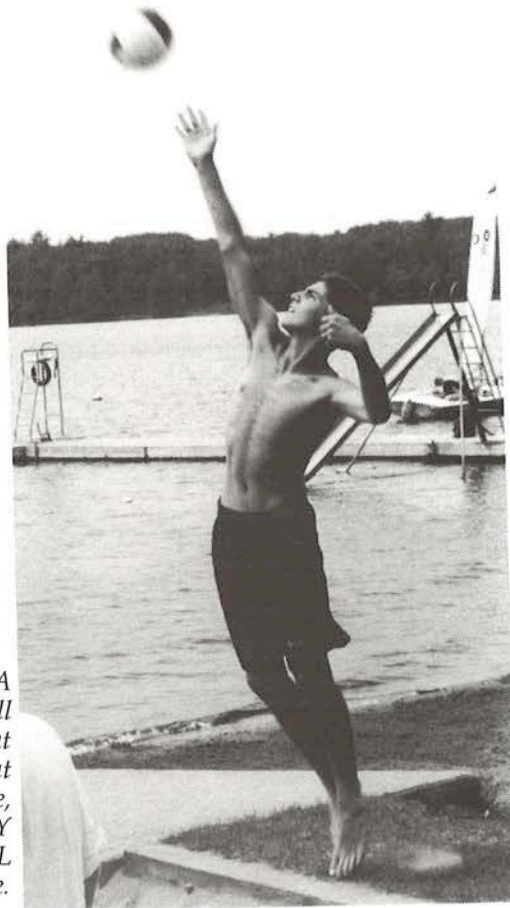

The MCAA Volleyball Tournament featured great play. Here, ANDY SCHIMEL nail a serve.

MCAA Volleyball Tourney Marked By "Cinderella Story"

JON KULESZA—

It was a perfect sunny day for a volleyball tournament

down on the recently improved beach volleyball court on the shore of Sand Lake. The Seniors started out and wound up playing a well played three hit tourney where players from the winning team included: BOBBY GOODMAN, HARLEY ROSENTHAL, REED EDWARDS, MIKE MASON, and ELLIOT PESSIS. With no prior playing experience as a team, these guys played excellent together. They won their championship match by a final score of 16-14 in a thriller.

In the early afternoon, the Intermediate teams played out on the beach volleyball court. It was a Cinderella story. A team with only three players against a team with five players in both rounds of the Tournament and came out on top. JOEL SORINSKY, BRIAN SUMERS, and JORDAN GAULE took the top prize.



LIEBERMAN AND SIMKIN BURN UP THE TRACK AT THE MCAA TRACK MEET

BYRAN WHITFORD—

The 1994 MCAA Track Meet saw a good number of athletes participate. The Meet was held on the athletic field on a beautiful day. Two divisions were made for the competition, 12 and under and 13 and over. There were five events in the Meet: the 50 yard dash, the 100 yard dash, the base run, the softball throw, and the grueling Old Counselor's Road Run.

In the 12 and under division, ELLIOT LIEBERMAN ran away with the competition. LIEBERMAN placed first in the 50 and 100 yard dashes and in the base run. BRETT GOLDNER stepped up to win the softball throw with a toss of 45 yards and PETE EHRlich won the OCR run. However, LIEBERMAN'S victories in the 50, 100, and base run gave him the title.

The 13 and over age division featured some tough competition. BRYAN SIMKIN would prove to be the man to beat as he rolled to victory with first place finishes in the 50, base run, and OCR run. DAVE LEZAK was a close second in the competition with a first place finish in the 100 yard dash and second place in the 50, base run, and OCR

run. JEREMY FRYDMAN easily won the softball throw with a throw of 66 feet. In the end, SIMKIN'S three wins put him on top.



Starter MARK CHAPIN looks down to MCAA Track Meet Official KOZ to see if JUSTIN "SPUD" HOROWITZ can start.

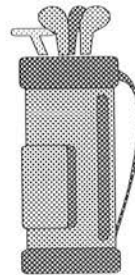

MCAA Golfers Vie For Trip To Eagle River Country Club

JASON "DOOGIE" BELCHER—

The Menominee Golf Tournament was held on the famous Menominee five hole course. The field of competi-

tors was divided into two divisions of 12 and under and 13 and over. The first to hit the fairways were the 12 and unders. Some top scores were put up by JOSH KURZMAN (29) and BRETT CHETEK (27), but ADAM KAPLAN led the age group with an outstanding 26.

Next came the 13 and over age division. Fine scores were put up by ANDY SCHIMEL (26), JEFF HOOD (26), JAKE GOLDNER (24), and TODD BLOCK (22). A tie for first was made by GABE POLSKY and JOSH MERSEFELDER, who both shot an unbelievable 21.

The top scorers in each age division won the prize of playing nine holes of golf at the Eagle River Country Club.

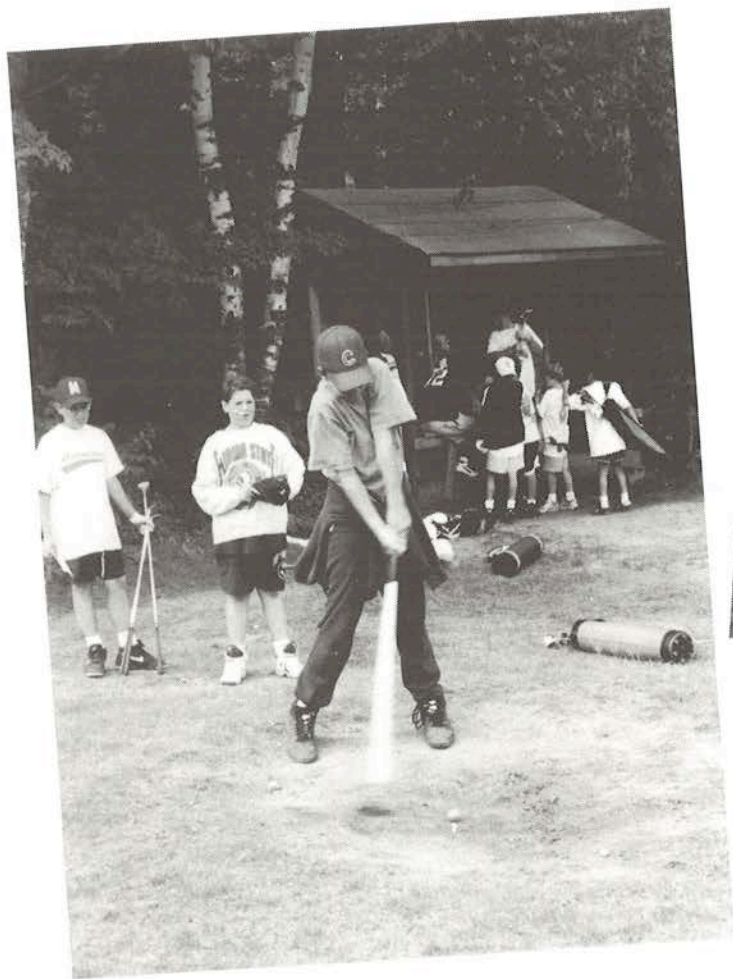

MATT FINDER and JOSH MERSEFELDER were two of the many golfers playing the C.M. Course in hopes of getting to play 9 holes in town.



MEGAPHONE

WHAT A WRAP-UP EDITION

AUGUST 3-5, 1994



Outstanding Sing Shows Greens Supreme

EVAN ROSENBERG—



The 1994 Green and White sing was truly an event to behold. First of all it occurred not on the night before the Relay, but instead, it took place the morning of the Relay (flexibility is the key word in camping after all). The actual Sing began with the Green team performing first. The Greens were led by co-captains MATT PASSEN and EVAN ROSENBERG, who miraculously situated their team at



The Greens, with the Eagle as their mascot, sang their way to victory.



In a moment of high tension, MARC BEERMANN reads the results.

the last minute. After the Green team exited, and re-entered, it was the White team's turn. The Whites were led by co-captains PHIL STERNHELL, and JEFF DAVIDSON. After the Whites finished, and re-entered, "H" announced that the judging was over, and both teams let out a sigh of relief. The Counselor Sing then followed and provided comic relief. After that, it was time to announce the winner. MARC BEERMAN took center stage, pulled out "the envelope", and looked at the results. After a short pause that lasted an eternity, he stated quite plainly, "The winner of the 1994 Green and White sing, are ...The Greens." Yes, with their mascot, the Menominee Soaring Eagle behind them, the Greens had captured the Sing by a decisive vote of 4 to 1. Both teams put out superlative efforts.

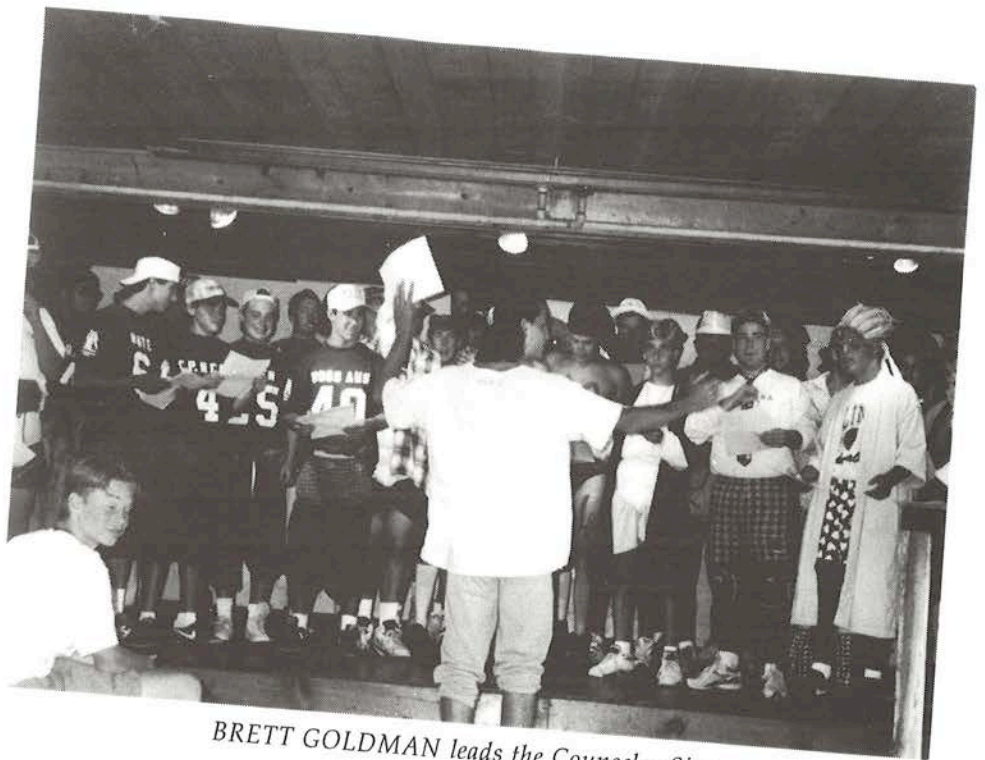

BRETT GOLDMAN leads the Counselor Sing

Green And White Sing



Hail Our Colors

Hail our colors, Green and White.
Lift your voices cheering!
Raise them high up to the sky
As we go marching on to victory!
To the best camp in the land
We pledge our loyalty!
Fight, fight, go team fight!
Triumph for Menominee!

To Menominee We Sing

To Menominee we sing,
As we let our voices ring,
Shouting her praises and her glory.
By our victories and fame
We bring honor to thy name,
Adding the pages to her story.
Green and White United
In triumph we stand
C.M.'s the finest in all of the land!
With our colors raised on high,
As our loyal sons run by,
Shouting "Menominee Forever!"

Traditional Green And White Songs

Grand Old Flag

We're on stage tonight,
With a victory in sight,
For the goal
Which we strive to attain.
As our voices soar,
We'll win once more,
Tradition we're proud to maintain.
Ev'ry man stands tall
As the memories recall
Every game where we rank supreme.

(Chorus)

We sing to thee, Menominee,
Keep your eyes on that great Green Team.

Green or White we stand
For the best in the land.
Win or lose we shall always be true.
As our men proclaim
Our hallowed name,
Inscribed in the things that we do.
With our spirit strong
We go marching along,
To fulfill each and every dream.

(Chorus)

When the season's done,
And we pack up and run,
As the view of the Sing fades away,
We will ne'er forget,
We owe a debt to C.M. we'll never repay.
With honor bright,
And our banner of might,
We go forth in a mighty stream.

(Chorus twice)



When Johnny Comes Marching Home

The White team's marching on tonight
We'll win, we'll win.
We'll give the Greens a mighty fight
To win, to win.
Our banner we will raise up high,
And let our voices reach the sky,
And we all will shout,
"The Whites are marching on!"

On the courts and on the fields
We'll win, we'll win.
The men in White will never yield
To win, to win.
Our boys will try in all they do
In songs — in games — in the Relay, too.
And all will shout,
"The Whites are marching on!"

The team is sure of victory,
To win, to win.
Our spirit spells Menominee,
We'll win, we'll win.
Green or White,
We're sure of a job well done.
We'll try our best each and every one.
And we all will shout,
"The White are marching on!!"



Green Song

(tune to "Bear Down Chicago Bears")

No fear, Menominee Greens
We're going to win the sing in '94

We are here, Menominee Greens
There's no quit in us
Just watch the score

Remember our great Green team tradition
Tops in all competitions

Look here, Menominee Greens
We're destined for green and white supremacy

Tonight the sing, then the relay too
Give a cheer, Menominee Greens!

(Drum Solo)
Repeat from Remember



We are the Whites

(To the tune of "When the Saints go Marching In")

We are the Whites
We are the Whites
We're going to win the sing tonight
We're here to prove our pow'r and might
First team is named the Whites

On the courts
And on the fields
Oh the Whites will never yield
We will always win the game
Green and White won't be the same

Here come the Whites
Here come the Whites
Check it out whose in the fight
It's the sing that's ours alright
Then the relay is in sight

We are the Whites
We are the Whites
We're going to win the sing tonight
We're here to prove our power and might
First team is named the Whites

Counselor Song

(To the tune of "Stairway To Heaven")

There's a place to the north
where the boys will come forth
And asked who are we, it's C.M.
When they get there they meet
their counselors who'll eat,
the candy which the confiscate.



There's a counselor named Ari,
who's better known as Ari.
And his tan looks like a penquin.
His co in cabin three,
whose tan is worse than he
but B.Q. would enjoy the privilege.

There's a counselor named Frank
who really used to stank,
this summer has a reason for smell good.
He borrowed Kulesza's van,
and on a day off it ran
out of gas, but Dawn came to save them.



On night's out it surely seemed,
a bowling alley was the thing,
after five weeks even townies look appealing.
All summer long, mom's and sisters came along,
Bullock's girl sure seemed ripe for stealing.

Peter Aplin took Zip's car,
and he went a little to far,
so he kept right on going to England.
Then Gavin got the call,
and went back to the hall
with Dorbart and Jeannie and them all.

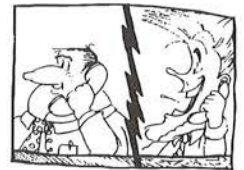

Gene Fleck is our caretaker
he's always on the make,
to improve our lives here off of Sand Lake.
To cross him you would dread,
because he's German bred.
And he claims you guys don't know what
you're doing.

CONTINUED ON NEXT PAGE...

....continued Counselors Song



Dean Andrew turned a year,
and whispered in doctor's ear,
is the washroom in the hallway or right here?
Cory sure speaks good Spanish,
at the social he did garnish
the attentions of a cute pre-teen dish.

Beers dog Flurry tends to pee,
on all the beds in cabin one-three,
but Bobby thinks that smell is simply he.
So Boutros wrote this song,
it may seem a bit too long,
But just think how fast this summer has really gone.



So campers it's time to say,
you did it the Menominee Way,
Thanks to you we'll all get our full pay.
Thanks Glenn, Dawn and more,
we love CM more than before,
and that's all owed to the counselors of '94.



Big Relay Win For Greens Takes Color War

MARC BEERMANN—



The Green and White Relay was an exciting event shared by both teams. MIKE WEINER and DAN "SKIPPY" ROSEN started the whole thing by crawling from the flagpole to home plate of Bob Bender Senior Diamond. The lead during the course of the Relay switched many times, but eventually a clear cut lead was established by the Greens. Both teams' fires were quick and quite impressive, as was JEREMY FRYDMAN'S rowing effort, which broke an oar in two. After having

difficulties passing the balloon up the hill, the Whites came back to make an exciting finish. However, the Greens held off the Whites and MATT PASSEN got the honors of smashing the balloon on the flagpole, finishing the Relay and winning Green and White outright for the Greens!



MARC BEERMANN prepares to start the 1994 Green and White Relay

The superb rowing of JEREMY FRYDMAN brought the White Team back in the Relay.



Green and White Scoreboard

Handball Game	Green		
Sandcastle Contest	Green		
Taps	Green		
Cheers	White		
Counselor Hunt	White		
Menominee Monopoly	White 1:37.41	Green 1:47.12	
Water Events	Green 11	White 4	
All Camp Clean-Up	White		
Spirit	White		
Spelling Bee	White		
Sing	Green		
Relay	Green		
Overall Winner			

Captain MATT PASSEN smashes the balloon on the flagpole to win the Relay and the competition outright for the Greens as fellow teammates look on in eager anticipation.



Five Year Night A Special Memory

One of the most important moments of Camp came last night with Five Year Night. The purpose of the evening was to recognize those campers and counselors who have been at camp for five years or more. This year, fourteen new initiates were entered into the Five Year Club. They were: ANDREW BENDER, JAKE GOLDNER, EVAN HERMAN, JON JAPHA, RICKY KIRSH, DAVID LEZAK, MATT PASSEN, BRETT RHEINGRUBER, TODD RHEINGRUBER, SETH RHEINGRUBER, DANIEL ROSEN, EVAN ROSENBERG, BRANDON SMITH, and DON VETTER.

Each new member was recognized before the entire camp in Wasserman Hall and was given a candle by a current member of the Club to signify their entrance into it, and of course, the gorgeous Five Year Jacket—with an emblazoned Soaring Eagle embroidered on the back and the campers name on the front. After the ceremony, the vans were loaded up for an evening at Fleck's Meadow Inn. While enjoying pizza fries and soda pop, names were thrown across the room from years gone by. It was a memorable evening.



DON VETTER models the new 5 Year Jacket.



ANDY SCHIMEL passes on the candle to new Five Year Club member DAVE LEZAK.

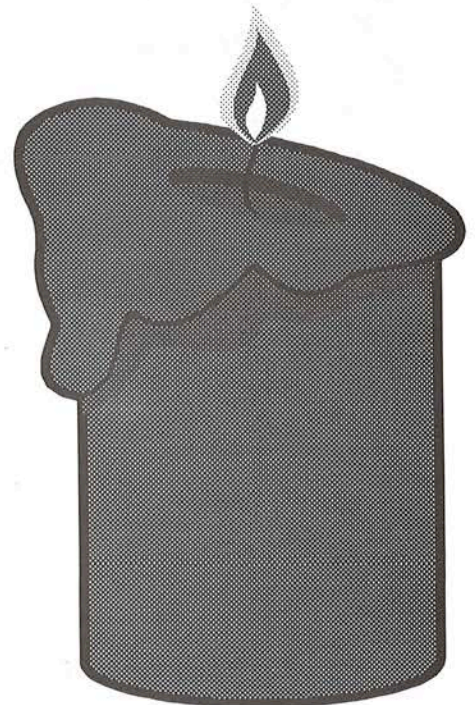

Five Year Club Members

Name	Years
DORIS WALKOWSKI	28
GLENN KLEIN	26
DENNIS KOSLOSKI	22
MARC BEERMAN	14
DAWN KLEIN	13
JEANNE NYHOLM	11
ARI BERNSTEIN	10
BRETT GOLDMAN	10
ROSS ALLEN	10
GENE FLECK	9
ARI ROSEN	9
JEFF DAVIDSON	7
NICK OLSON	7
CORY PROVUS	7
DAVID WOOD	7
TODD BLOCK	6
HOWARD ROTHENBERG	6
ANDY SCHIMEL	6
JASON SCHWARTZ	6
ALAN TRUBOW	6
MATT WEISS	6



JAKE NEIMAN shows off this year's 3 Year Jersey.



After the ceremony, all members of the 5 Year Club went to Fleck's Meadow Inn to celebrate.



Intermediate Twi-Light League Championships Finish In A Flurry

The 1994 Intermediate Twi-Light League Championship Series was a best two out of three. Gaule's Gill-Gutted Gefilte Fish took on Grant's Giant Gonzangas for the title. GRANT'S team, which had just come from a comeback win a semi-final's series against Lieberman's Lethal Lasagna Lumps, found themselves on an emotional high. GAULE'S team had fought hard as well to make it to the Finals.

In the first game, GAULE'S Team led by the offensive fire power of PETER EHRLICH and RYAN HOLZ earned Gaule's Gill-Gutted Gefilte Fish a 1-0 lead in the series.

The second game saw GRANT'S team jump to an early lead as SIM DARWICK and JAKE NEIMAN smacked the ball around the field. However, the consistent pitching of BRETT GOLDNER and solid defense held the Gonzanga offense in check late in the game. GAULE'S team took the lead in the third, never to relinquish it again as they batted around the order. When the game ended, Gaule's Gill-Gutted Gefilte Fish had wiped out Grant's Giant Gonzangas to win the 1994 Intermediate Twi-Light League Championship.

Alex's All-Stars Atop Advanced

BRYAN SIMKIN—

The first ever Advanced Twi-Light League Championship had to be the most exciting and intense game for every player on each team of the Twi-Light League season. The teams potted against each other were Alex's All-American All-Stars, captained by ALEX YUSPEH and Teddy's Terrorizing Torpedoes led by captain TED ROTH. After taking the first game, YUSPEH'S team felt confident in the

best two out of three series. In the second game, YUSPEH'S team's defense was stingy, and allowed no runs in two back to back innings for ROTH'S team at the plate.

YESPEH'S team went on to win the title in two straight games. ALEX got a softball saying that he was the first Advanced Twi-Light League Champion ever. YUSPEH did a great job.

We all had a great and fun season.

Spuds Mash Competition In Junior TLL

FRANK JOHNSON—

In the Junior Twi-Light League Championships, Spuds Potatoes battled Jordan's Nike Flights. JUSTIN HOROWITZ received a bye to the Championship series by virtue of having the regular season best record. JORDAN ROTHSTEIN'S got to the finals by winning a grueling five game series against Zephyr's Soaring Eagles captained by JOSH ZEMEL. Spuds Potatoes came out strong and won the first two games of the best of five series. ANDREW DRAFT, the league MVP, helped lead a high potent offense. In the field, JARED OLIAN and JUSTIN HOROWITZ let on grounders by the left side. It looked like it was going to be a sweep. However, the Nike Flights never gave up and pulled out game three with offensive punch by ROTHSTEIN and JOSH HELLER. In the end, Spuds proved to be too powerful at the plate and golden in the field. They won game four rather easily. Junior Twi-Light

League was a pleasure for me to be commissioner for my second year, and everyone involved had a great season.

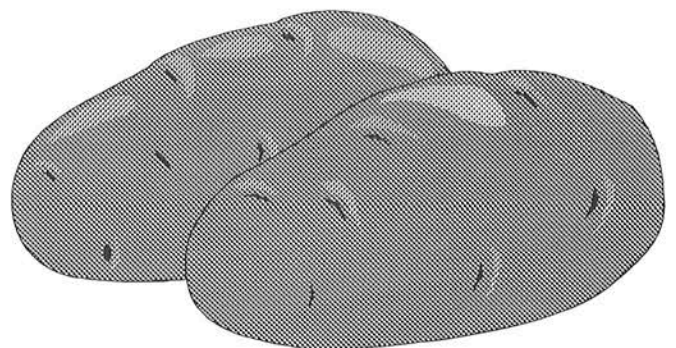

*Captain GABE
POLSKY holds up
the Steve Ehrlich
Senior Twi-Light
League Trophy with
his team around
him.*



Steve Ehrlich Trophy Goes To Polsky Pig Plop Downs Water Lillies

JON KULESZA—

After two long first round series, the two last place teams found themselves in the Senior Twi-Light League Championship. Reid's Rampaging Water Lillies met Polsky's Pulsating Pig Plop in the best of three series on the Bob Bender Senior Diamond.

The first game went to POLSKY'S team. Some great defensive plays were made by the eventual league MVP, GABE POLSKY, along with teammates ANDY SCHIMEL and CHICO WEISS. Unfortunately for BARTHA'S team, who previously had come back from a 3-0 deficit in a best of seven series, they lost the first game 5-0.

In the second game, both teams were fired up and ready to go. BARTHA'S team jumped up 2-1 in the first inning by the power hitting of JEFF DAVIDSON.

In the bottom of the second POLSKY'S team ripped the Water Lillies for six runs. Great hits were delivered by SCHIMEL, DAVE CHERNR, JOSE VILLAVICENCIO, and captain GABE POLSKY.

BARTHA'S team scored two more in the top of the third but it was not meant to be. POLSKY'S team was just to good on this beautiful, chilly evening. Polsky's Pulsating Pickled Pig Plop won 15-5 on route to the STEVE EHRLICH Trophy, which goes for the second year in a row to Glencoe. All members names will be engraved on the EHRLICH Trophy, and captain GABE POLSKY will have the honor of polishing it all winter.

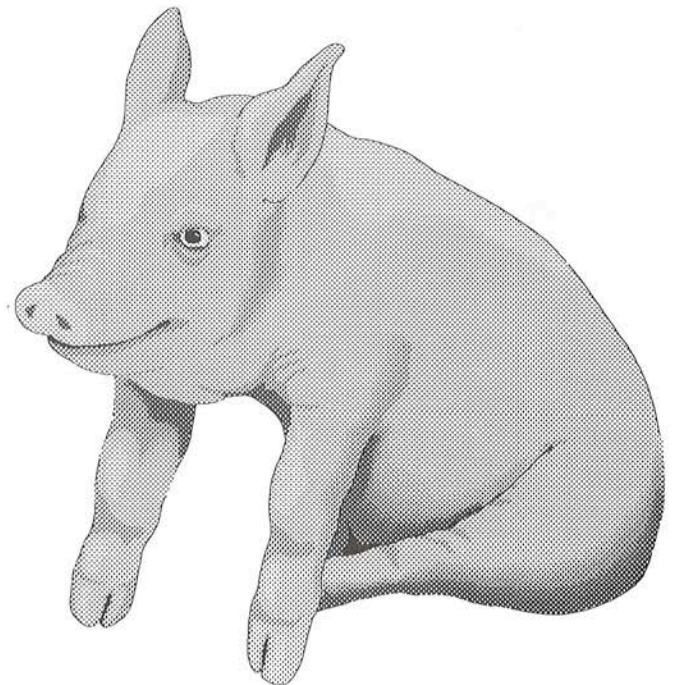

Banquet Closes Another Awesome Summer At C.M.

The final evening of C.M. '94 was highlighted by the annual Banquet. With the entire camp cleaned up, the traditional Banquet meal was served. The appetizer was a shrimp cocktail, followed by a trip to the salad bar. The main course included steak, corn on the cob, and twice baked potatoes. The dessert was the ever-popular and perennial candidate for seconds, Baked Alaska.

After the meal had been digested, the final Twi-Light League Championship Games were finished up, and it was just about time to chalk up another Awesome season in the C.M. record books. There was still more memories to be had this summer, though. The following morning, a bed of steam covered Sand Lake, with the sun coming just over the horizon on a clear and crisp morning. One more unique memory in a summer that had so many.



As the sun came over the horizon on the last morning of Super Camp 1994, steam rose from Sand Lake.



Awards

Arts And Crafts

Pallet Award

MATT GROSS

JUSTIN JACOBSON

Boat Regatta

Skipper Award

AARON EAGLE

Speedy Boat Award

BRAD BROOK

JUSTIN JACOBSON

Hockey MVP's

Conn Smythe

ANDREW DRAFT

Norris

MARTY WEISMAN

Unsung Hero

OREN JACOBSON

Volleyball

King Of The Court

REED EDWARDS

All State Award

SETH RHEINGRUBER

Above The Net Award

AARON EAGLE

Football

Player Of The Year

ENRIQUE LONA

Tubing

Hardest To Get Off

TOM BUDASZ

Most Air

JEFF STEIN

Archery

Most Improved

ERIC ISRAEL

HARRIS KEALEY

Riflery

Shooter Of The Year

BRETT GOLDNER

Most Improved

TED ROTH

Best New Shooter

SIM DARWICK

Skiing

Skier Of The Year

EVAN ROSENBERG

Most Improved

MATT COHEN

Best New Skier

MATT FRANK

Sailing

Sailor Of The Year

JASON HORN

Golf

Golfer Of The Year

TODD BLOCK

Tennis

MVP

ALEX YUSPEH

MIP

ADAM SCHREIER

Soccer

MVP

JOSH KURZMAN

Basketball

Mr. Hustle

SIM DARWICK

Mr. Clutch

SCOTT SCHAFF

MIP

COLIN TAHI

Coach's Award

BRIAN ANDALMAN

Twilight League

Junior

MVP

ANDREW DRAFT

Gold Glove

JUSTIN HOROWITZ

Best Attitude

JOSH HELLER

Intermediate

MVP/

Batting Champ

SIM DARWICK

Home Run/

RBI Champ

PETER EHRLICH

Advanced

Triple Crown

BRYAN SIMKIN

Senior

MVP

GABE POLSKY

RBI Champ

JEREMY FRYDMAN

Batting/ Home

Run Champ

MATT PASSEN

Hardball

Most Coachable

JARED OLIAN

Big Stick

JEREMY FRYDMAN

*Game Ball From
12 & Under vs.*

St. Germain

Al Lewis

Balls Of Fame

SIM DARWICK

Softball

16A Ball from

OJ Games

Balls Of Fame

NATE WASSERMAN

JON JAPHA

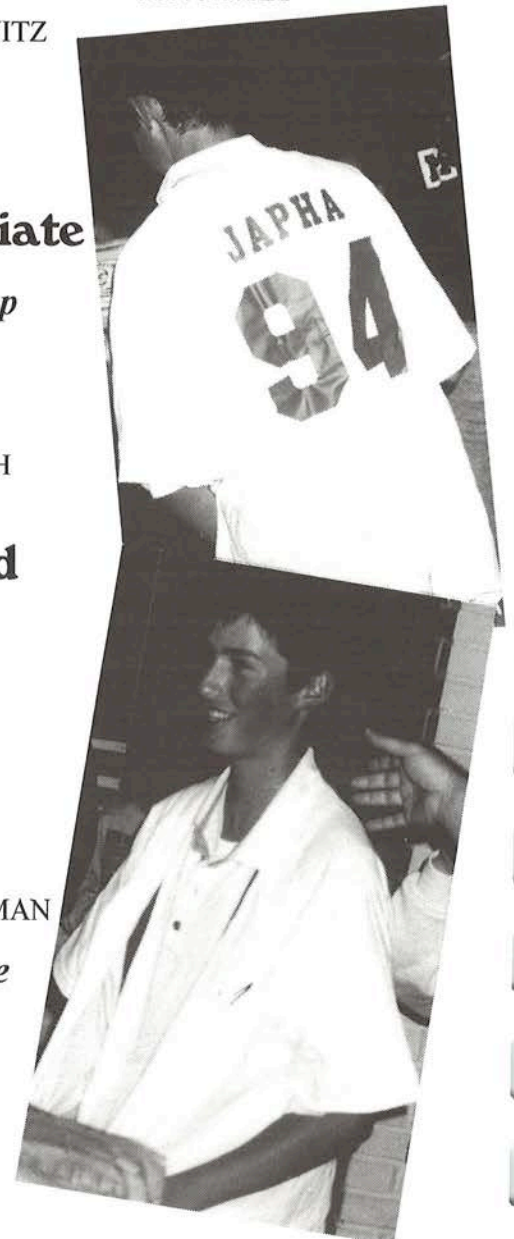

The Most Important Things I Have Learned In Life Through

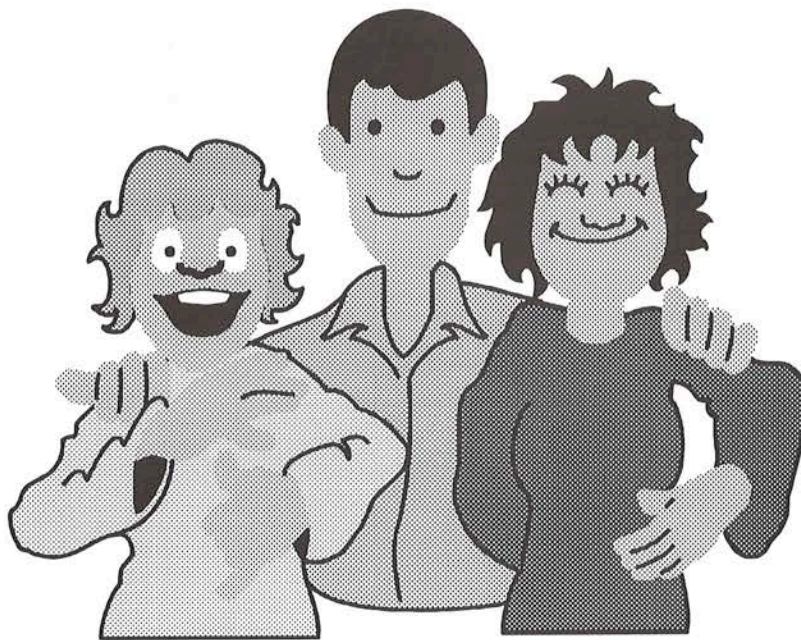

July 3, 1994...

*If anyone is wondering as to how this list of pithy phrases came about, it has a story behind it as does almost everything else that goes into a Megaphone Annual. The story involves CM A.D. MARK CHAPIN and his girlfriend CARY who bought GLENN and DAWN two books as reciprocation for letting MARK have an extra day off. One of these books is entitled **The Most Important Things I've Learned In Life** edited and compiled by Beau Bauman, a 16 year old who became curious as to what other people thought were the most important things in life. So, he wrote to people and collected 370 witty sayings about what are the most important things people have learned in their lives. While our list may not contain as many sayings as Beau's, the contents are certainly just as interesting. So here is a list compiled from members of the CM staff of 1994.*

Humble yourself enough to ask for help whatever the situation. Always remember the one you can trust.
—ROBERT LEWIS EMERY

A person must love and accept himself. This includes all his faults, fears, shortcomings, and misdirections. If a person walks through life dwelling on past mistakes or carries around a black cloud of guilt, he will never be able to weather these storms of his personality. When one can look in the mirror, into the eyes of his soul, and say, "I truly love you," he will be able to smile the rays of his life to others' clouds.
—JOPLIN JAMES SELL

"A person doesn't stay defeated because of what happens to him but within him." Whether at a sports camp or a business deal a person can choose to be defeated!

I've had a lot of minor difficulties throughout my life. Examples: sprained ankle, bad flus, fender benders, however, if I keep these things in perspective I'll be fine. In other words, "If that is the worst thing that ever happens to me, I'll be lucky."

Finally, Laugh and the world laughs with you — cry and you cry alone!
—JON KULESZA

Know the one who knows.
—GLENN KLEIN

Life is like a tin of sardines... We're all crammed in together, and nobody can find the key.

Value your friends — respect their feelings and put yourself in their shoes as often as possible. Strive to get to know as many people with as many views on life as possible and learn from their experience or lack of experience.

There is *always* a tomorrow.
—GAVIN SPOWAGE

Live deep whilest you live.
Know peace and yet know passion.
Appreciate the moment; it's gone before you know it.
Don't look *too* hard at the future, it'll come.
Do not contend.

Treasure others.
—*MARK WALTON*

Be yourself solely because no one else can be you.
Know your limits but reach for the brass ring.
Never feel out of place — get to know people.
LEARN FROM EVERYTHING.
—*JOSH ROTHENBERG*

Be aware and open minded thus accepting people for who they are. This will allow you to see good where there is bad and enjoy yourself to the full.
—*MARCUS D. ZAVOS*

No matter how difficult the situation, never give up.

Learn a second language.

—*BRYAN WHITFORD*

Wherever you are, whatever you are doing, remember that there is always somebody somewhere that loves you.
—*CARL ROWLAND*

THINK AGAIN.
—*ANDREW PINGER*

Always strive to be the best possible person you can be. If you feel like you can't achieve a certain task, try until you can. Once that happens, set another goal. If you do this you can never be a loser, ONLY A WINNER.
—*BARRY QUAYLE*

Family and friends are the most important things in life. You can have millions of material things, but without family and friends to be there for you and for you to be there for them, the material things are worthless.
—*ARI ROSEN*

Life will make all kinds of twists and turns, but it will all come back to the decisions you make and what you do with them.
—*CORY PROVUS*

Stop. Listen. Relax. Think. React, and do what you know is right.
—*ANDY ZLOTNIK*

To be successful is to know at least one life was made a little bit easier by your presence...
—*MIKE BURLING*

Life's a never ending roller coaster. You might as well enjoy it.
—*ALAN TRUBOW*

Learn what you can, when you can.
Teach what you can, when you can.

STUFF HAPPENS! SO WHAT!
—*BERNIE CUNNINGHAM*

Love yourself, because the only way you can love anyone or anything else is to love yourself first.
—*FRANK JOHNSON*

Things will always work out for the best in the end. What happens, happens for a reason which will eventually always turn out for the best as long as you keep faith.

P.S. Never swing at ball four.
—*BRETT GOLDMAN*

Learn to enjoy the simple things in life; accept what they are and learn to appreciate the fact that you have them.
—*JASON WHITE*

Set goals in all aspects of your life.

“The glass is always half full.”
—*MARK CHAPIN*

Give it your best shot and don't give up until you do.
—*STEWART AUSLANDER*

The most important things I've learned in life are to be attentive, to understand, and to decide.
—*ARI BERSTEIN*

Never be selfish for it is the root of all evil; always think of everyone else first.
—*ANDY BULLOCK*

To be happy with whatever you have although always aiming and striving for higher and better. To respect others and treat them and their things the way you would want to be treated.
—Gary “Tone” Turner
Happiness for myself and those around me.
—*MARC BEERMAN*

Care about yourself before caring for others.
Know yourself, so you can know another.
Treat others as you wish to be treated.
Listen to people, if you wish to become better.
—*JASON BELCHER*

The most important things in life are those things which are let go.
—*CRAIG ZIPPERER*

All people need problems in their lives. They are impasses to overcome. Once accomplished, the thrill of completion fulfills one for a moment, and the circle starts over again. People with only minor problems in their lives will escalate the importance of those problems just to give themselves something to worry about.
—*JASON SCHWARTZ*

The most important things I learned in life:
Values
Loyalty
Human Relationships
—*DROR NAFTALY*

Don't fool yourself or lie to yourself. If you do this you will know who you are, what you stand for, and why you are here.

—ROSS AUSLANDER

Know that there is one thing that you can do better than anyone else. Along the same lines, be the one who know, have something in your head that exceeds the capacity of everyone else.

—NICK OLSON

Being a friend with nature and gain its respect. Keeping my family, my friends, and myself happy and content. To make sure the highs are cherished and the lows are accepted with grace.

—DEAN ANDREW

Knowledge, determination, and love are the bonds that hold together universal mankind.

—GREG ABRAMS

I really like "locker room" slogans. Most say a lot in very few words. The two I like best are:

- 1) Excellence in any activity is not a final result, but is a never ending, life-long journey.
- 2) Never lose your desire to learn something new.

—DENNIS KOSLOSKI

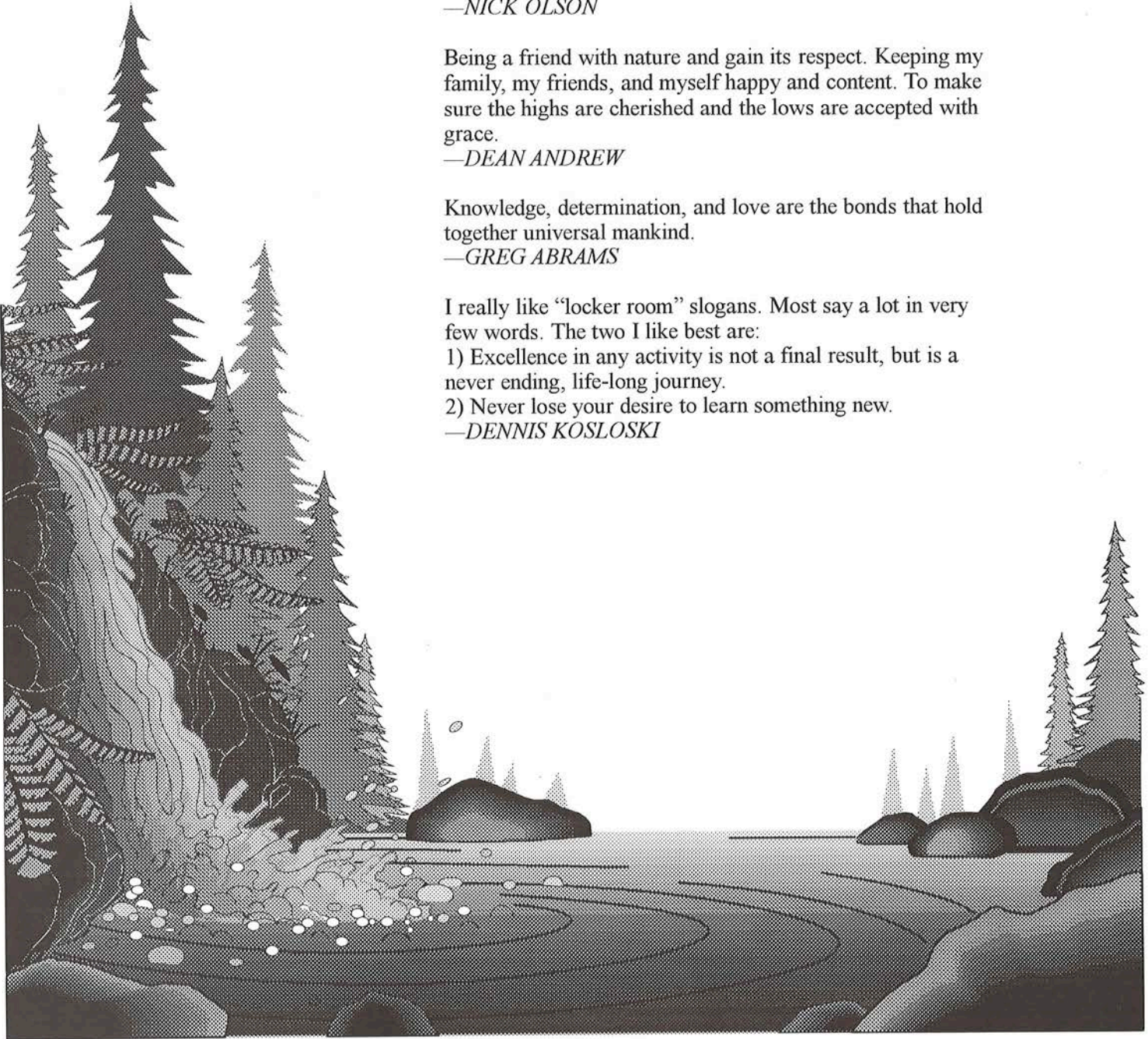



MEGAPHONE

CABIN LIST EDITION

AUGUST 5, 1994



Camp Menominee Cabin List

THREE

JUSTIN CLOUSE
 BRANDON DAVIS
 ANDREW DRAFT
 JOSHUA HELLER
 HARRIS KEALEY
 JESSE LATORRE
 J.D. McCORMICK
 JARED OLIAN
 MATTHEW SCHWARTZ
 ALEX STEIN
 Counselors
 BARRY QUALYLE
 ARI ROSEN
 GAVIN SPOWAGE

FOUR

JEREMY EMER
 JUSTIN HOROWITZ
 ERIC ISRAEL
 ROB KOHEN
 JAMES McGOVERN
 MICHAEL REICH
 JORDAN ROTHSTEIN
 ERIC STANG
 JOSH ZEMEL
 Counselors
 JOSH ROTHENBERG
 BRYAN WHITFORD
 MARCUS ZAVOS

FIVE

MATTHEW HOLLANDER
 JASON HORN
 BRANDON LEVY
 ELLIOT LIEBERMAN
 BRADLEY ROSS
 JEFFERY STEIN
 JAMEY STENGEL
 BRAIN SUMERS

ADAM WEINGARTEN
 SAM YUSPEH
 Counselors
 NICK OLSON
 JOOPLIN SELL
 MAREK WALTON

SIX

RENE HERTSBERG
 MATTHEW KLEIN
 DOUG LEVIN
 JEREMY MATIMORE
 ELI PLATT
 JARED RALSKY
 BRETT RHEINGRUBER
 DANIEL ROSEN
 JON SIEGEL
 NICHOLAS TALBOT
 JARRET TURBIN
 Counselors
 ROSS AUSLANDER
 GARY TURNER

SEVEN

JOSHUA BENJAMIN
 JEFF DAVIDSON
 DREW EDWARDS
 BRETT GOLDNER
 MATTHEW GOODSTEIN
 ADAM GREENBERG
 JAY GUSTAFSON
 CASEY HINTZ
 BRETT PESSIS
 SCOTT SCHAFF
 Counselors
 ALAN TRUBOW
 JASON WHITE

EIGHT

JAVIER BASAGOITI
 MATT BERCOVITZ
 GEORGE BURDEN
 CHRIS DICKEY
 MICHAEL HERTZ
 JOSH KURZMAN
 PABLO MAYO
 TOMMY NUTTER
 JONATHAN WALTON
 COLIN WEINER
 Counselors
 ANDREW PINGER
 JASON SCHWARTZ
 CARL ROWLAND

NINE

SIM DARWICK
 MANUEL ESCALANTE
 MATT FINDER
 STEPHEN GOLER
 EVAN HARRIS
 ETHAN HOROWITZ
 DAVID KRAUT
 JASON KUMMER
 BRIAN ZAANDER
 Counselors
 STEWART AUSLANDER
 JASON BELCHER
 MARK CHAPIN

TEN

ANDRES ARAIZA
 PETER BERNICK
 CHRISTOPHER CADY
 BRETT CHETEK
 PETER EHRlich
 JOHNATHAN FELDMAN
 JORDAN GRANT
 DAVID SCHWARTZ

MICHAEL WEINER
BRIAN WHITE
Counselors
BERNIE CUNNINGHAM
CORY PROVIS
ROBERT EMERY

FOURTEEN

JORDAN GAULE
ADAM KAPLAN
MATT KAUFMAN
KEANAN LEVANT
JAKE MEILACH
BRAD MENDEL
MIKE MESIROW
JAKE NEIMAN
ANDY SLUSSER
MICHAEL SOLOVY
STEPHEN STEIN
Counselors
GREG ABRAMS
ERIK ECKBALD

FIFTEEN

JJEREMY GLAZMAN
JEFFERY HERTZ
MICHAEL HIRSH
RYAN HOLZ
OREN JACOBSON
KEI KATO
JUSTIN MATIMORE
JOEL SORINSKY
Counselors
ARI BERNSTEIN
ANDY BULLOCK

ELEVEN

TREVOR ABRAMSON
RONJON DATTA
JAMES DICKEY
ROSS EDWARDS
LEONARD FIALHO
ANDERS JOHNSON
SCOTT KAPLAN
SETH RHEINGRUBER
JOE ROSENBAUM
HARLEY ROSENTHAL
ALEX YUSPEH
Counselor
JON KULESZA

TWELVE

JBRIAN ANDROW
MATT COHEN
JEFF DRITZ
MATT FRANK
PHILIPPE IFERGAN
LARRY MILLER
CRAIG RASHKOW

TED ROTH
MATT ROTHSTEIN
JOHNNY SCHATZ
COLIN TAHI
ZACK WEINER
Counselors
DEAN ANDREWS
FRANK JOHNSON

SIXTEEN

ANDREW BENDER
DAVID DAVIDSON
STUART EMMERMAN
EVAN HERMAN
DANNY LEVY
HERBIE LUKES
JOSH MERSFELDER
BRAD MOSS
BRYAN SIMKIN
BRIAM TEPPS
Counselor
CRAIG ZIPPERER

SEVENTEEN

JOSE BASAGOITI
BRAD BROOK
TOM BUDASZ
JORDAN GOLDFARB
MATTHEW GROSS
JOHN JACOBS
JUSTIN JACOBSON
ENRIQUE LONA
TODD RHEINGRUBER
BARRY SCHWRTZ
TODD SCHWARTZ
ROSS SIDER
Counselor
ANDY ZLOTNIK

ONE

BRIAN ANDALMAN
DAVID CHERMER
REED EDWARDS
JOE JACKSON
STEVEN KATZ
DAVID LEZAK
MICHAEL MASON
AARON PERNA
ELLIOT PESSIS
ADAM SCHREIER
BRANDON SMITH
Counselors
MIKE BURLING
DROR NAFTALY

TWO

TODD BLOCK
JAKE GOLDNER
JEFF HOOD

NICK HOUCHENS
JON JAPHA
RICKY KIRSH
ENRIQUE OJEDA
ANDY SCHIMEL
MATTHEW WEISS
Counselor
BRETT GOLDMAN

THIRTEEN

REID BARTHA
JEFF DAVIDSON
AARON EAGLE
JEREMY FRYDMAN
BOBBY GOODMAN
MATT PASSEN
GABE POLSKY
EVAN ROSENBERG
PHILIP STERNHELL
JOSE VILLA VICENCIO
Counselor
MARK BEERMANN

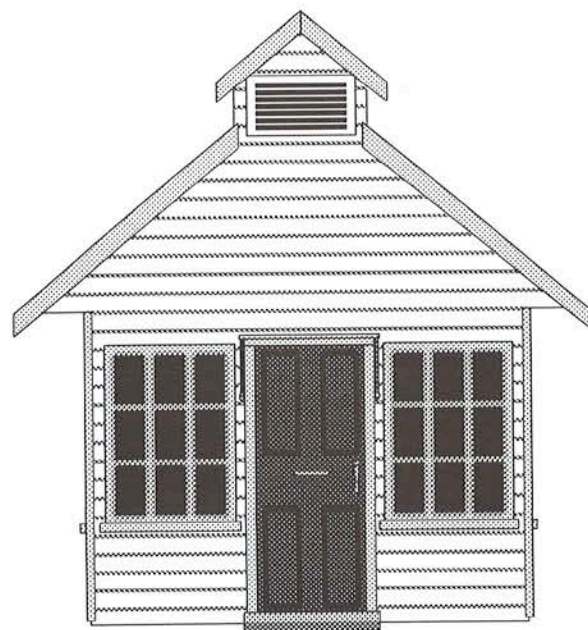



MEGAPHONE

WHAT WOULD IT BE? EDITION

AUGUST 5, 1994



CABIN ONE

What would Cabin 1 Be Without Laziness?

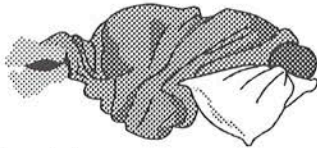

What would ARRON PERNA be without screaming?
 What would DAVE CHERNER be without books?
 What would JOE JACKSON be without the rafters?
 What would BRIAN ANDALMAN be without basketball?
 What would STEVE KATZ and ADAM SCHREIER be without their left hand?
 What would MIKE MASON be without wake-up call?
 What would DAVE LEZAK be without newspapers?
 What would BRANDON SMITH be without his flashlight?
 What would ELLIOT PESSIS be without BRANDON and ADAM?
 What would REED EDWARDS be without words?
 What would DROR NAFTALY be without a rifle?
 What would MIKE BURLING be without his car keys?

CABIN TWO

What would Cabin 2 Be Without Nights Out?



What would RICKY KIRSH be without squirts?
 What would MATT WEISS be without NICK HOUSHENS?
 What would JAKE GOLDNER be without a younger brother?
 What would ANDY SCHIMEL be without tradition?
 What would ENRIQUE OJEDA be without his glasses?
 What would NICK HOUSHENS be without three showers a day?
 What would TODD BLOCK be without Betty and Veronica?
 What would JEFF HOOD be without 14 days at C.M.?
 What would JON JAPHA be without a jersey in the Mess Hall?
 What would BRETT GOLDMAN be without 20th Century Fox?

CABIN THREE

What would Cabin 3 Be Clean Underwear?



What would A.J. STEIN be without hockey?
 What would J.D. McCORMICK be without GLENN?
 What would BRANDON DAVIS be without a leader?
 What would JARED OLIAN be without a dictionary?
 What would ANDREW DRAFT be without basketball?
 What would MATT SCHWARTZ be without his math?
 What would HARRIS KEALEY be without his controversy?
 What would JUSTIN CLOUSE be without JESSE?
 What would JESSE LATORRE be without space?
 What would JOSH HELLER be without opie senior?
 What would ART ROSEN be without his apron?
 What would BARRY QUAYLE be without his neatness?

CABIN FOUR

What Would Cabin 4 Be Without "Brazil Won!", Cookies, and Chocolate Sundaes?



What would JEREMY EMER be without cabin poker?
 What would ERIC STANG be without his piano?
 What would JOSH ZEMEL be without Marimata socials?
 What would ERIC ISRAEL be without cookies?
 What would ROB KOHEN be without his cheezy grin?
 What would MIKE REICH be without a Brazil World Cup victory?
 What would JORDAN ROTHSTEIN be without great counselors?
 What would JAMES McGOVERN be without Arts and Crafts?
 What would JUSTIN HOROWITZ be without the six a.m. bee sting?
 What would BYRAN WHITFORD be without the proper padding?
 What would MARCUS ZAVOS be without the waterfront?
 What would JOSH ROTHENBERG be without his picture on his driver's license?

CABIN FIVE

What Would Cabin 1 Be Without Their Whining?



- What would MATT HOLLANDER be without sweeping duty?
- What would ELLIOT LIEBERMAN be without JASON'S Gameboy?
- What would JASON HORN be without a mop?
- What would ADAM WEINGARTEN be without his mail?
- What would SAM YUSPEH be without his holy sheets?
- What would BRIAN SUMERS be without?
- What would BRAD ROSS be without his eating habits?
- What would JAMEY STENGEL be without his Chinese herbs?
- What would JEFF STEIN be without the Arts and Crafts keys?
- What would BRANDON LEVY be without late night discos?
- What would NICK OLSON be without vegetarian meals?
- What would JOPLIN SELL be without Kara?
- What would MAV WALTON be without his hairy chest?

CABIN SIX

What Would Cabin 6 Be Without Its Clogged Toilet?



- What would RENE HERTSBERG be without questions?
- What would JEREMY MATIMORE be without rollerblading?
- What would MATT KLEIN be without gum?
- What would BRETT RHEINGRUBER be without five years at C.M.?
- What would NICK TALBOT be without canteen?
- What would JARRET TURBIN be without basketball?
- What would DOUG LEVIN be without "Dougie Fresh"?
- What would JON SIEGEL be without "Coed Naked"?
- What would JARED RALSKY be without tennis?
- What would ELI PLATT be without cheese pizza?
- What would DAN ROSEN be without his glove?
- What would ROSS AUSLANDER be without winning the spelling bee?
- What would TONE TURNER be without being a Certified Pro?

CABIN SEVEN

What Would Cabin 7 Be Without Clean-up?



- What would ADAM GREENBERG be without Bull's stuff?
- What would JOSH BENJAMIN be without chick mail?
- What would SCOTT SCHAFF be without an attitude?
- What would CASEY HINTZ be without Schnorkle Moose?
- What would BRETT GOLDNER be without laziness?
- What would BRETT PESSIS be without PMS?
- What would JAY GUSTAFSON be without a question?
- What would MATT GOODSTEIN be without "Goody"?

- What would DREW EDWARDS be without a flashlight?
- What would JEFF DAVIDSON be without having a "J"?
- What would ALAN TRUBOW be without Meta Lake?
- What would JASON WHITE be without Eddie Munster?

CABIN EIGHT

What would Cabin 8 Be Without Being Amazingly Clean?



- What would JOSH KURZMAN be without soccer?
- What would MARTY WEISMAN be without hockey?
- What would JAVIER BASAGOITI be without the moon?
- What would MATT BERCOVITZ be without his counselor training?
- What would COLIN WEINER be without his baseball game?
- What would TOMMY NUTTER be without "I'm coco the clown!"?
- What would PABLO MAYO be without "Birdy, Birdy, Birdy!"?
- What would MIKE HERTZ be without his CARL like wit?
- What would JON WALTON be without brilliance in basketball?
- What would GEORGE BURDEN be without his Wisconsin sweatshirt?
- What would CHRIS DICKEY be without Super Camp?
- What would JASON SCHWARTZ be without the very last wake-up call?
- What would ANDREW PINGER be without his 70's clothes?
- What would CARL ROWLAND be without "Rollin...Rollin...Rollin"?

CABIN NINE

What would Cabin 9 Be Without The Lion King CD?

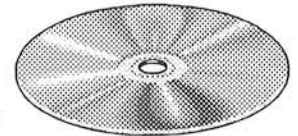

- What would SIM DARWICK be without a broom?
- What would BRIAN ZAANDER be without this "...alrighty then."?
- What would ETHAN HOROWITZ be without Star Trek?
- What would EVAN HARRIS be without the Knicks?
- What would MATT FINDER be without the Cubs?
- What would STEPHEN GOLER be without hockey?
- What would DAVID KRAUT be without his water bottle?
- What would JASON KUMMER be without his hackeysack?
- What would MANUEL ESCALANTE be without his pictures?
- What would STEW AUSLANDER be without NATE?
- What would MARK CHAPIN be without Muskie Murf?
- What would JASON BELCHER be without the HAKA?

CABIN TEN

What would Cabin 10 Be Without "Bloody Torches?"



What would PETER EHRLICH be without doorknobs and toothpaste?
What would DAVID SCHWARTZ be without "the dance"?
What would CHRIS CADY be without pictures?
What would MICHAEL WEINER be without amazing bed jumping?
What would ANDRES ARAIZA be without his little community?
What would JORDAN GRANT be without Pippen and his music?
What would JONATHAN FELDMAN be without comics?
What would BRIAN WHITE be without shinning his flashlight?
What would PETER BERNICK be without Monopoly?
What would BRETT CHETEK be without stunts?
What would BERNARD CUNNINGHAM be without a 30 second chin-up bar hang?
What would ROB EMERY be without being a drill sergeant?
What would CORY PROVUS be without the ability to blend in with Cabin 10 Campers?

CABIN ELEVEN

What would Cabin 11 Be Without A Perfect 100?



What would JAMES DICKEY be without his nickname?
What would SCOTT KAPLAN be without his Cindy Crawford poster?
What would TREVOR ABRAMSON be without his following capabilities?
What would ANDERS JOHNSON be without his Chris Farley imitation?
What would HARLEY ROSENTHAL be without his making fun of people capabilities?
What would ROSS EDWARDS be without his Tropical Tango Dance?
What would RONJON DATA be without his nap time during general?
What would ALEX YUSPEH be without Steve Miller?
What would BARRY SCHWARTZ be without Cabin 11?
What would KING LEONARD FIALHO be without his wacky sense of humor?
What would SETH RHEINGRUBER be without leading cabin clean-up?
What would JOE ROSENBAUM be without Snoop Doggie Dog and his Gat?
What would JON KULESZA be without his big butt and his "Rat ta tat tat, I'll bust your wit some caps, baby!"?

CABIN TWELVE

What would Cabin 12 Be Without Bofa?



What would JOHNNY SCHATZ be without his screams?
What would BRIAN ANDROW be without his Sega?
What would COLIN TAHI be without Nirvana?
What would CRAIG RASHKOW be without soccer and soccer?
What would MATT ROTHSTEIN be without baseball?
What would ZACK WEINER be without tennis?
What would MATT FRANK be without guitar?
What would PHILLIPE IFERGAN be without showers?
What would MATT COHEN be without waterskiing?
What would JEFF DRITZ be without his soccer ball?
What would LARRY MILLER be without his bed?
What would JUSTIN JACOBSON be without the mural?
What would TED ROTH be without the Star Spangled Banner?
What would FRANK JOHNSON be without New Al Lewis Field?
What would DEAN ANDREW be without being out?

CABIN THIRTEEN

What would Cabin 13 Be Without The Senior Trip?



What would JEREMY FRYDMAN be without "beeeceep!"?
What would JEFF DAVIDSON be without the go-karts?
What would MATT PASSEN be without the jet skies?
What would AARON EAGLE be without twenty-five marshmallows?
What would BOBBY GOODMAN be without the shower?
What would PHIL STERNHELL be without skiing?
What would REID BARTHA be without his basketball?
What would JOSE VILLAVICENCIO be without making great sports?
What would GABE POLSKY be without waking up early?
What would EVAN ROSENBERG be without the Green Team?
What would MARC BEERMANN be without his hand in a plastic bag?

CABIN FOURTEEN

What would Cabin 14 Be Without A New Floor?



What would ADAM KAPLAN be without his persistence?
What would BRAD MENDEL be without his saying, "You're so stupid!"?
What would MIKE MESIROW be without his saying, "That's incredible!"?
What would MIKE SOLOVY be without his Gamegear?
What would ANDY SLUSSER be without his Gameboy?
What would JAKE NEIMAN be without his "chick mail"?
What would JORDAN GAULE be without his silk shirt?

What would JAKE MEILACH be without his rambunctious personality?
 What would MATT KAUFMAN be without his stunts?
 What would KEANAN LEVANT be without his spray bottle?
 What would STEPHEN STEIN be without his books?
 What would GREG ABRAMS be without Suave?
 What would ERIK ECKBALD be without "Pink Sleepy Floyd LLOYD"?

CABIN FIFTEEN

What would Cabin 15 Be Without Indoor Paddleball?



What would JUSTIN MATIMORE be without his "image"?
 What would JEREMY GLAZMAN be without backflips over his bed?
 What would JOEL SORINSKY be without his flopped Stupid Human Trick?
 What would RYAN HOLZ be without sleep-walking?
 What would OREN JACOBSON be without his squirt bottle?
 What would JEFF HERTZ be without eating pillows while sleeping?
 What would KEI KATO be without his bed for everyone else to sit on?
 What would MIKE HIRSCH be without his voice?
 What would ARI BERNSTEIN be without writing this?
 What would ANDY BULLOCK be without Andrea?

CABIN SIXTEEN

What would Cabin 16 Be Without A Counselor?



What would BRYAN SIMKIN be without his incredible hitting?
 What would ANDREW BENDER be without his clutch "3"?
 What would DAVID DAVIDSON be without being a counselor?
 What would STU EMMERMAN be without wanting more BIG 10?
 What would EVAN HERMAN be without the Roller Rink?
 What would DANNY LEVY be without his dog on Visiting Day?
 What would HERBIE LUKES be without his Kansas hat?
 What would JOSH MERSFELDER be without his golf clubs?
 What would BRAD MOSS be without TE?
 What would BRIAN TEPPS be without his Chucky T's?
 What would ZIP be without the World Cup?

CABIN SEVENTEEN

What would Cabin 17 Be Without BF 1994?



What would MATT GROSS be without Arts and Crafts?
 What would BRAD BROOK be without Agawak?
 What would JOHN PATRICK JACOBS be without fire?
 What would TOM BUDASZ be without the doctor's daughter?
 What would ROSS SIDER be without a high five?
 What would ENRIQUE LONA be without his glasses?
 What would JOSE BASAGOITI be without tennis?
 What would TODD RHEINGRUBER be without his Bob Marley?
 What would JORDAN GOLDFARB be without his stereo?
 What would JUSTIN JACONSON be without "The Mural"?
 What would TODD SCHWARTZ be without Doc's Run?
 What would BARRY SCHWARTZ be without his hair?
 What would ANDY ZLOTNIK be without his visor?

Menominee Medley Music

MENOMINEE, MENOMINEE

Menominee, Menominee,
Hats off to thee,
To our colors, true we shall ever be.
Firm and strong, united are we.
With a rah, rah, rah,
For the Green and White,
Rah, Rah, Rah, Rah, Rah, for Menominee!
Once Again!
(Repeat once)

HAIL OUR COLORS

Hail our colors, Green and White.
Lift your voices cheering!
Raise them high up to the sky
As we go marching on to victory!
To the best camp in the land
We pledge our loyalty!
Fight, fight, go team fight!
Triumph for Menominee!

HAIL TO MENOMINEE

Hail to Menominee,
All hail to thee. (Hail to thee!)
We'll pledge allegiance
As we follow trails
That lead right back to
Dear old Menominee.
Our hearts are true (Hearts are true!)
We'll carry Green and White
Forever more in victory to you!

TO MENOMINEE WE SING

To Menominee we sing,
As we let our voices ring,
Shouting her praises and her glory.
By our victories and fame
We bring honor to thy name,
Adding the pages to her story.
Green and White United
In triumph we stand
C.M.'s the finest in all of the land!
With our colors raised on high,
As our loyal sons run by
Shouting "Menominee Forever!"

BRIGHT AS A SUNBURST

Bright as a sunburst, high in the sky,
C.M. enters with a victory cry!
With plenty to sing of,
And plenty to say,
Let's give a cheer now, hip, hip hooray!

(Chorus)

We're the best camp in the North Woods!
Number one, the finest.
In Megaphones they will enshrine us.

Green and White colors flying above,
This old camp is the camp that we love!
We'll keep returning after school ends,
Back to Menominee, back to our friends.

(Chorus)

Spirits of many, bonded as one,
Living together under the sun.

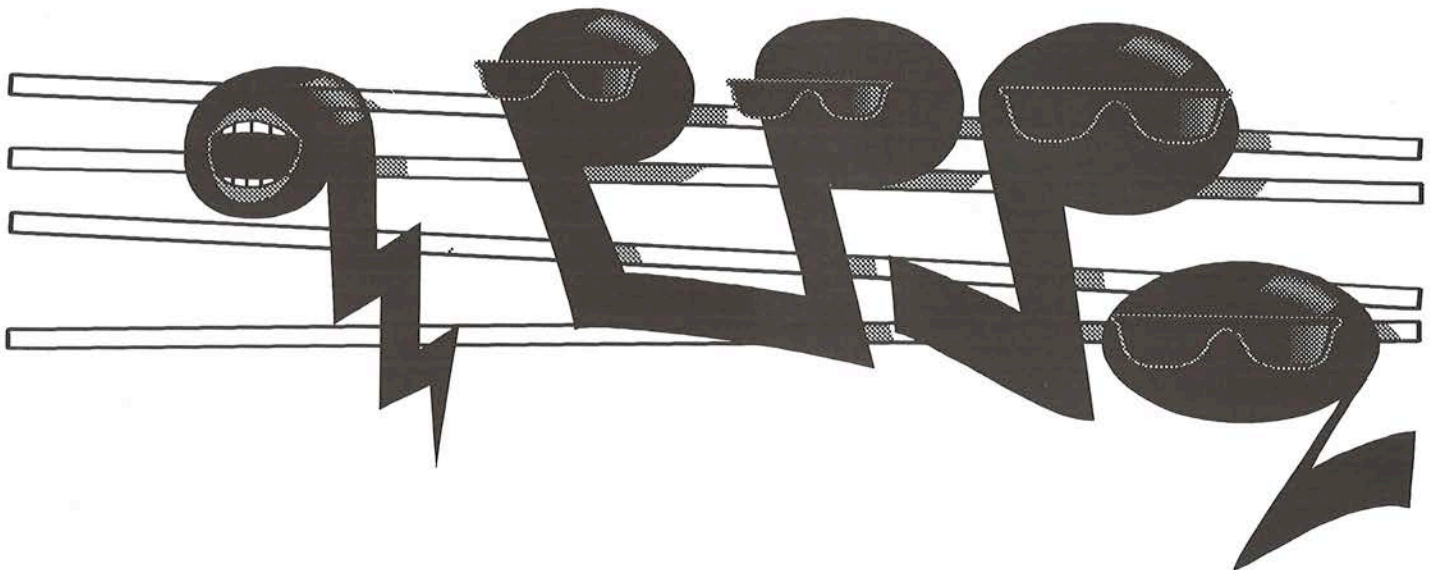

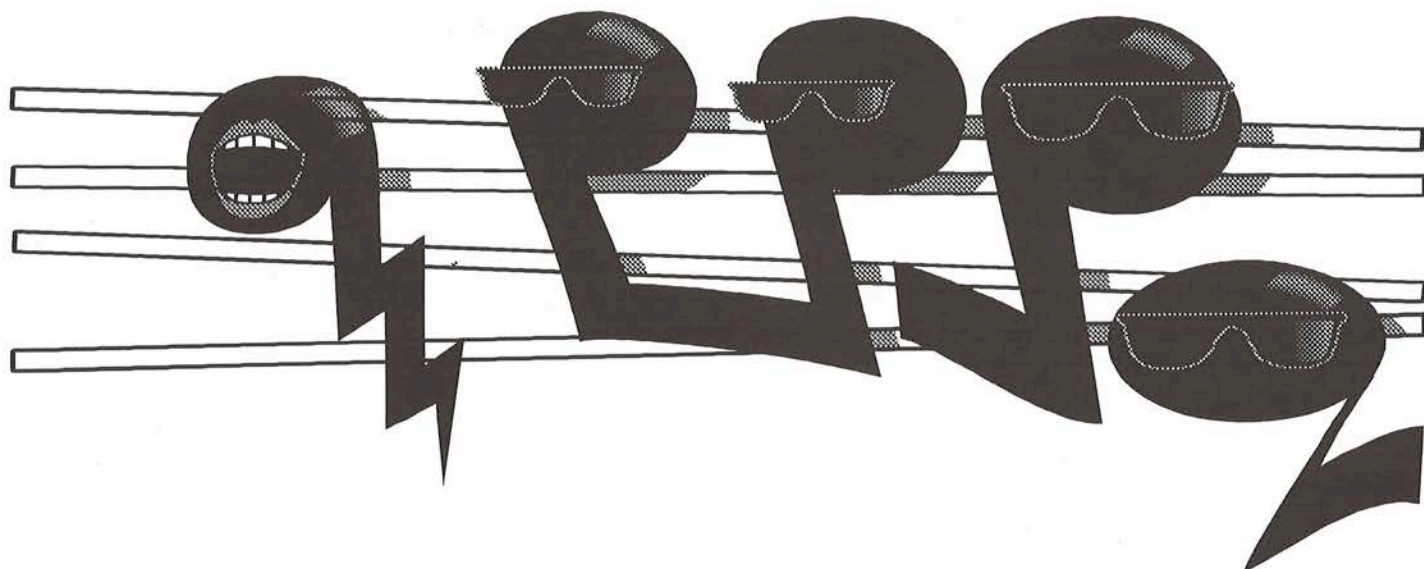

ONE FOR ALL FOR MENOMINEE

*(To the tune of "Do You Hear The People Sing"
from LES MISERABLES)*

Do you hear the voices ring,
Singing the praises of the men?
They are the voices of our campers
Who will never quit again!

When the beating of your hearts
Echoes the beating of the drum,
One for all, and all for one,
For Menominee!

Will you stand and give a cheer,
And make a vow again this year?
Fight for victory
And make the effort for us here!

Take pride in the sight
Of the Green and White family!

Do you hear the voices ring,
Singing the praises of the men?
They are the voices of our campers
Who will never quit again!

When the beating of your hearts
Echoes the beating of the drum,
One for all, and all for one,
For Menominee!

FILL A STEIN

Fill a stein,
Sing a song to Menominee.
In our hearts, more than long
We'll remember thee.
We shall ne'er break our ties
With Menominee,
For she lives in our memory.
So up, up, up,
Raise your cup up to your eyes.
Let your shouts rise to the sky.
Fill a stein, sing a song,
To the camp of our hearts,
For we'll e'er love Menominee.

MENOMINEE'S FIVE YEAR SONG

Here's to Camp Menominee,
May she live forever!
May we always faithful be,
And our bonds ne'er sever.
Though our troubles may be nigh, Boys,
With our standards raised on high, Boys,
We'll be loyal to Menominee.
Ever loyal to our Camp, Menominee.

Menominee Music

THE TITANIC

Oh, they built the ship Titanic to sail the ocean blue.
And they thought they'd built a ship that the waves could ne'er break through.
But the good Lord raised his hand, and he said it should not stand.
It was sad when the great ship went down.

(Chorus)

Oh, it was sad, Oh, it was sad.
It was sad when the great ship went down to the bottom of the sea.
Husbands and wives, little children lost their lives.
It was sad when the great ship went down.

(Chorus)

Now they were not far from England, they were not far from shore,
When the rich refused to associate with the poor.
So they out them down below, where they'd be the first to go.
It was sad when the great ship went down.

(Chorus)

They put the lifeboats out on the rough and raging sea,
When the band struck up playing "Nearer My God To Thee."
Little children wept and cried as the waves swept o'er the side,
It was sad when the great ship went down.

(Chorus)

The ship was full of sin, and the sides were about to burst,
When the Captain shouted, "Women and children first!"
Oh, the Captain tried to wire, but the lines were all afire.
It was sad when the great ship went down.

(Chorus)

PHILY WOOF (To the tune of The Yale Fight Song)

Phily Woof, Phily Woof, Bow,
Wow, Wow, Menominee.

Phily Woof, Phily Woof, Bow,
Wow, Wow, Our Team will
never fail.

When the Green and White
takes the field,

Bow, Wow, Wow, that is the
Team we hail.

Phily Woof, Phily Woof, Bow,
Wow, Wow, Menominee.

TAPS

Day is done.
Gone the sun.
From the lakes,
From the hills,
From the sky.
All is well.
Safety rest.
God is nigh.

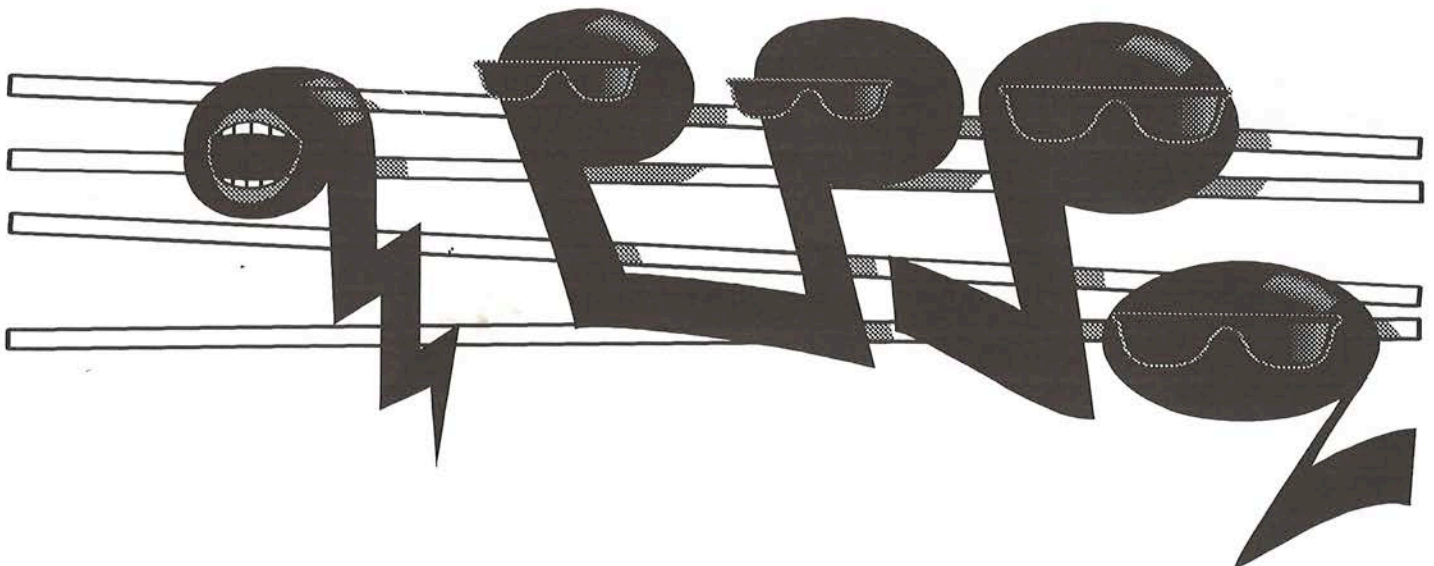



YEAH, RAH, RAH...

Menominee Cheers!!

ALVEVO

Alvevo, Alvivo,
Alvevo, vivo vum! Hey!
Go get a rat trap!
Bigger than a cat trap!
Go get another one
Bigger than the other one!
Rah, Rah, Sis Boom Bah!
Menominee, Menominee, Yeah!

A Dissertation on the Meaning of ALVEVO

by *BRETT GOLDMAN Ph.D. MDA. A.C.E. AT&T—*

Throughout history, words have been the construct of human contact. What separates man from animal is our ability to express our feelings in an intelligent and verbal manner whilst revealing a side of hidden emotion and suppressed meaning. Great works of literature have been written. Names like Melville, Shakespere, and Steinbeck have graced our eyes and ears with some of the most prolific, and utterly profound prose in human history. But to understand the true nature of human existence, I believe I have found the key, the Rosetta Stone of human nature, if you will. It lies in the words and expression of ALVEVO. Yes, ALVEVO. How can a cheer reveal the nature of man? Allow me to enlighten.

ALVEVO, ALVIVO, ALVEVO VIVO VUM, HEY!
Just mish mosh or a tap into the human psyche? After extensive research I have found the true meanings of those first words. ALVEVO is descended from early Latin, a root of the phrase *Alvo viv uso*, which of course

means, "Long live the rutabaga". It is plain to see that man is highly concerned with his diet. His emphasis on life is an early indication that civilized man was concerned with the future. The rest of the words are various outer dialects of the region, thus emphasizing the point.

GO GET A RAT TRAP BIGGER THAN A CAT TRAP. The use of the modern English is highly intriguing at this point. It seems to point to a regression in the intellectual base of the human psyche. One might even relate it to a Freudian regression back onto infancy. The comparison between the opposites of the rat and the cat, one being a predator of the other and the insinuation that we are attempting to catch them both, highlights the superiority of man in the food chain. We are the dominant species and thus can catch a rat and a cat using a trap and our genius.

GO GET ANOTHER ONE BIGGER THAN THE OTHER ONE. It is recently discovered that this line was added in by a two year old as an immature rebuttal to his older brother. His older brother than said "Myuhh mnuye muyhh..."

RAH RAH SIS BOOM BAH. These are obvious references to the ancient Egyptian deities. Rah was of course the god of the sun, By invoking the name it is calling the sun forth and then asking for his sister, Boombah, who was the deity of battle or competition, for help. This clearly demonstrates man's inferiority to nature. But interestingly enough, man has in recent centuries overcome nature by the use of domes.

MENOMINEE, MENOMINEE, YEAH! In hours upon hours of research, I could not find any meaning for these words as relating back to the early Latin. I can only hazard a guess and hope that it only supports my hypothesis that this phrase further sheds light into the inner workings of human nature.

So, in conclusion, ALVEVO is obviously a great deal more than just words being yelled to increase heart rate and adrenaline production. There is a core message

of human existence and superiority hidden in the mystic words. We are at once both dominant and submissive, and, and ahhhhh, well, oh, forget it.

AKA LAKA CHING

Aka Laka Ching! Hey!
Aka Laka Chow! Hey!
Aka Laka Ching Ching!
Chow, Chow, Chow! Hey!
Booma Laka, Booma laka, Sis Boom Bah!
Menominee, Menominee, Yeah!

BOOMA LAKA

Five Booms!
Boom, Boom, Boom, Boom,
Booma Laka, Booma Laka, Bow, Bow, Bow!
Chinga laka, Chinga Laka,
Chow, Chow, Chow!
Booma laka, Chinga Laka,
Who are we?
We are the men from Menominee!
Hey Rah, Rah, Rah, Rah, Rah!
Hey Rah, Rah, Rah, Rah, Rah!
Hey Rah, Rah, Rah, Rah, Rah!
Yeaaaa, Menominee!!

ITSZOO ROTSZOO

Itszoo, Rotszoo,
Teddy Boom Botszoo!
Osh Tillie Atzah, Teddy Boom Bah!
Teddy Roo, Teddy Roo,
Teddy Rah, Teddy Rah,
Teddy Rubby, Dubby, Dubby, Dubby,
Sis Boom Bah!
Menominee, Menominee, Yeah!

PEACHES AND CREAM

Peaches and cream,
Peaches and cream,
We're the boys of Menominee!
We're not rough,
We're not tough,
But, boy, are we enthusiastic!!

OOGIE LABANGA

Oogie Labanga,
Iggie the Piggie Wiggie!
Effo the Deffoweffo!
Ooo Wa, Ooo Wa!
Menominee, Menominee, Yeah!

SCA DOO

Sca Doo!
Skit That Daddewa!
Oooooo, Da Wadda Wadda!
Scadawa!
Yeah!
Menominee!



HAKA —Challenge—

Ka Mate, Ka Ora
2x

KaMate, Ka Ora
Tenei te tangata
Ouhurahura
Nana i tiki mai
Whakawhiti te ra.
A Hupane (Hupane)
A Hupane, Kaupane
Whiti te ra.

Tis Death, Tis Death.
Tis Life, Tis Life
Behold this hairy man.
It was he who
saw daylight.
Lo and Behold
All is Clear.

ORIGIN:

A Warrior chief - Te Rauparaha was being chased by another tribe. He hid. As the other people (war tribe) ran past, and he was free, he shouted "Ka Mate, Ka Mate...."

ECHO CHEERS

WE'VE GOT SPIRIT!!

BIG GREEN HANDS, BIG GREEN FEET!!

WE DON'T MESS AROUND!!

I WENT DOWN TO THE RIVER!!

I SAID A BOOM CHICKA BOOM!!

SOUND OFF!!

ALEPH BETS

Aleph Bets, Gimmel Dalled.
Our great team is mighty solid.
Izzy-Isey-Jakey Sam,
We're the boys who eat no ham!

Matzoh, Matzoh,
That's our cry!
Matzoh, Matzoh,
'Til we die!
Yeah, Menominee!

TWO BITS

Two bits, four bits,
Six bits, a dollar.
All for Menominee
Stand up and holler!!





MEGAPHONE

HAPPY BIRTHDAY STAFF EDITION

AUGUST 5, 1994



January

- 8 Carol McLoughlin '67
- 12 Joplin Sell '74
- 14 Cathy Sullivan '94
- 15 Marcus Zavos '73
- 19 Jason White '75
- 25 Brett Goldman '73

February

- 3 Ari Rosen '78
- 19 Jennifer Vetter '76
- 26 Nerida Sherlock '69
- Andrew Pinger '75
- 28 Josh Rothenberg '78

March

- 5 Robin Krause '76
- 7 Howard Rothenberg '69

April

- 2 Robert Emery '75
- 16 Michael Burling '71
- 21 Mark Chapin '72

May

- 1 Dror Naftaly '71
- 16 Alan Trubow '78
- 22 Rose Fleck '37
- 30 Doris Walkowski '94

June

- 16 Donald Vetter '74
- 24 Margot Sherlock '74

July

- 1 Frank Johnson '71
- 4 Dennis Kosloski '49
- 5 Gary Turner '71
- 7 Cory Provus '78

- 11 Dean Andrew '67
- 13 Andy Zlotnik '74
- 14 Chris Lube '64
- 22 Jenny Koenig '76

STAFF

Happy Birthday

BIRTHDAYS

To You! Whoo!

August

- 5 Bernard Cunningham '72
- 15 Erik Eckblad '73
- 27 Jacqueline Pye '74
- 31 Ross Auslander '78
- Stewart Auslander '78

September

- 10 Greg Abrams '78
- 13 Ross Allen '58
- 16 Carl Rowland '74
- 20 Terry Zmek '94

October

- 3 Barry Quayle '64
- 12 Jason Belcher '74

November

- 7 Jason Schwartz '78
- 9 Bryan Whitford '75
- 15 Craig Zipperer '72

December

- 1 Jon Kulesza '71
- 3 Eugene Fleck '91
- 16 Ari Bernstein '76
- 23 Nicholas Olson '77
- 26 Andy Bullock '73
- 27 Marek Walton '72
- 28 Gavin Spowage '75
- 29 Jeanne Nyholm
- 30 Marc Beermann '71

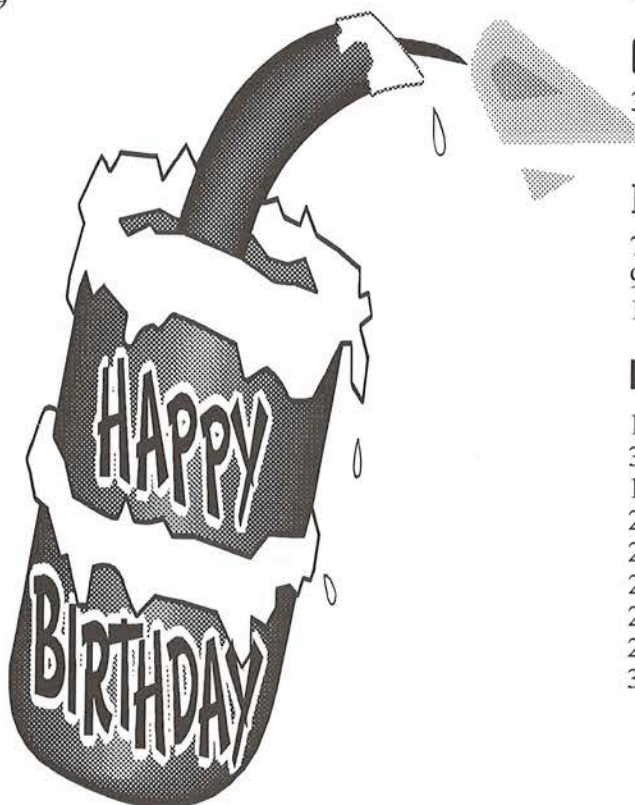

1994 Staff Addresses

Greg Abrams
1760 Midland
Highland Park, IL 60035
708-831-2966

Ross Allen
10 Widford Road
Welwyn Garden City, Herts
AL72LR
ENGLAND
011-44-0707-331959

Dean Andrew
18 Hawke Street
Parkdale
3195
AUSTRALIA
011-61-3580-6003

Ross Auslander
1982 Burr Oaks Lane
Highland Park, IL 60035
708-831-3119

Stewart Auslander
1982 Burr Oaks Lane
Highland Park, IL 60035
708-831-3119

Marc Beermann
632 Alsace Circle
Buffalo Grove, IL 60089
708-520-7619

Jason "Doogie" Belcher
57 McGregor Street
Palmerston North
NEW ZEALAND
063569598

Ari "Doc" Bernstein
1351 Ridge Road
Highland Park, IL 60035
708-831-3021

Andy Bullock
1302 North Lincoln
Bloomington, IN 47408
812-336-1928

Mark Chapin
524 1/2 Lake Street
Eau Claire, WI 54701
715-833-9471

Bernard Cunningham
143 McLennans Road
Plenty
3090
AUSTRALIA
011-34-357536

Erik "Lloyd" Eckblad
815 East South Street
Appleton, WI 54911
414-832-7998

Robert Emery
300 Cottonwood #1207
Waco, TX 85741
602-742-4580

Eugene Fleck
9035 Highway H
Eagle River, WI 54521
715-479-7182

Rose Fleck
9035 Highway H
Eagle River, WI 54521
715-479-7182

Brett "Boutros" Goldman
110 East Chalmers
Champaign, IL 61820
217-367-1953

Mike Hoff
1758 College
Stevens Point, WI 54481
715-342-4752

Dr. Thomas and Cindy Holmes
3230 Thayer Street
Evanston, IL 60201
708-475-4099

Frank Johnson
1067 Lincoln
Galesburg, IL 61401
309-295-6017

Dr. Danny and Lisa Kniaz
621 Skokie South
Glencoe, IL 60022
708-835-1458

Jenny Koenig
S816 Karau Avenue
Spencer, WI 54479
715-659-4170

Dennis "Koz" Kosloski
810 Green Street
Manitowoc, WI 54220
414-684-3763

Robin Krause
S3649 St. Highway 13
Spencer, WI 54479
715-659-5847

Dr. Jerry and Marcia Kraut
1026 Juniper Terrace
Glenview, IL 60025
708-998-1178

Jon Kulesza
2240 Eastview
Des Plaines, IL 60018
708-296-1552

Dr. Steven and Peg Manson
W5724 Hypoint Drive
LaCrosse, WI 54601
608-782-7300

Carol McLoughlin
Flat 4, No. 5 Turner St.
Leicestershire
L316WY
ENGLAND
0533854824

Dror Naftaly
Bachar Zeev St 33ND
Tel-Aviv
ISRAEL
3399276

Jeanne Nyholm
Box 644
Woodruff, WI 54568
715-356-2372

Nicholas Olson
17 Sugar Maple Trail
Madison, WI 53717
608-833-3559

Andrew Pinger
3304 West Torquay Road
Muncie, IN 47304
317-284-0062

Cory Provus
75 Prospect Avenue
Highland Park, IL 60035
708-433-2076



Jacqueline Pye
50, Beauvale Rd. The Meadows
Nottingham
ENGLAND
0602862095

Barry Quayle
309 D Brown Street
Oshkosh, WI 54901
608-985-7051

Ari Rosen
3065 Parkside Drive
Highland Park, IL 60035
708-432-4780

Howard "H" Rothenberg
1521 Johnson Drive Apt. 822
Buffalo Grove, IL 60089
708-215-8005

Josh Rothenberg
4708 North 9th
McAllen, TX 78504
210-687-8057

Carl "Rawhide" Rowland
27 Manor Drive
Fenstanton, Huntingdon
Cams.
UNITED KINGDOM
011-44-480464094

Jason "Bear" Schwartz
1921 Burr Oaks Lane
Highland Park, IL 60035
708-831-5934

Joplin Sell
929 West Carroll Street
Macomb, IL 61455
309-836-8203

Margot Sherlock
215 Backforest Road
Berry NSW
2535
AUSTRALIA
044641681

Nerida Sherlock
215 Backforest Road
Berry NSW
2535
AUSTRALIA
044641681

Dr. Michael Wood
Dr. Laurie Spencer
4243 N. Forest Hills Blvd.
Janesville, WI 53545
608-757-0055

Gavin Spowage
Glenochil Bungalow
Menstrie, Clackmannanshire
FK11 7EG
SCOTLAND
0259761321

Dr. Stuart and Kathy Stein
427 Stonemont Drive
Fort Lauderdale, FL 33326
305-389-1961

Cathy Sullivan
5179 Highway D
Eagle River, WI 54521
715-479-6250

Alan "Boner" Trubow
3171 Whisperwoods Court
Northbrook, IL 60062
708-559-8484

Gary "Tone" Turner
Yew Tree Cottage
Bishopstone, NR Aylesbury
Bucks, HP1785F
ENGLAND
0296-748438

Donald Vetter
RR1, Box 126
Moffit, ND 58560
701-387-4735

Jennifer Vetter
RR1, Box 126
Moffit, ND 58560
701-387-4735

Doris Walkowski
8465 Highway O
Eagle River, WI 54521
715-479-8612

Marek "Mav" Walton
10 East Parkside
Edinburgh
3H165XJ
SCOTLAND
011-44-316683937

Jason "Eddie" White
832 East 9th Street
Mishawaka, IN 46544
219-259-6549

Bryan "Meadowlands" Whitford
615 West Johnson #1032
Madison, WI 53706
201-896-0136

Dr. Bill and Donna Wittert
2640 Appletree Lane
Northbrook, IL 60062
708-498-8881 or 3434

Marcus Zavos
Yaffle Hill, Yaffie Rd.
S-G-H Weybridge, Surrey
KT13 0QF
ENGLAND
011-44-932848242

Craig Zipperer
1308 Illinois
Stevens Point, WI 54481

Andy Zlotnik
1473 Horizon Point
El Cajon, CA 92020
619-588-0098

Terry Zmek
9070 Highway H
Eagle River, WI 54521
715-479-2082





MEGAPHONE

HAPPY BIRTHDAY CAMPER EDITION

AUGUST 5, 1994

January

- 3 Colin Tahi '81
- 7 Jeffrey Hertz '82
- 16 Stuart Emmerman '81
- 17 Andres Araiza '82
- 18 Jeff Davidson '79
- Brett Goldner '83
- 19 David Davidson '81
- Ryan Holz '82
- 23 Josh Mersfelder '81
- 24 Matt Bercovitz '83
- Doug Levin '83
- 26 Matt Rothstein '81
- Justin Matimore '82
- Matthew Klein '83
- 27 Brad Moss '81
- Joseph Klein '86
- 29 Joshua Benjamin '83
- 31 Drew Edwards '83

February

- 1 Matthew Hollander '83
- Jordan Rothstein '84
- 5 Jeff Dritz '81
- 7 Pablo Mayo '82
- 8 Craig Rashkow '81
- 9 Jeremy Glazman '82
- Jacob Klein '87
- 13 Michael Reich '84
- 14 Jared Ralsky '83
- 19 Adam Schreier '80

March

- 1 Jason Horn '83
- 2 Bobby Goodman '79
- Justin Horowitz '84
- 4 Colin Weiner '83
- 5 David Kraut '82
- 7 John Patrick Jacobs '81
- 10 Matt Kaufman '82
- Jared Olian '84
- 11 Jordan Goldfarb '81
- 13 Jose VillaVicencio '78
- 16 Peter Ehrlich '82
- 17 Alex Stein '86
- 18 Rene Hertsberg '83



Super Happy Birthday Camper To You!-Whoo!! Birthdays

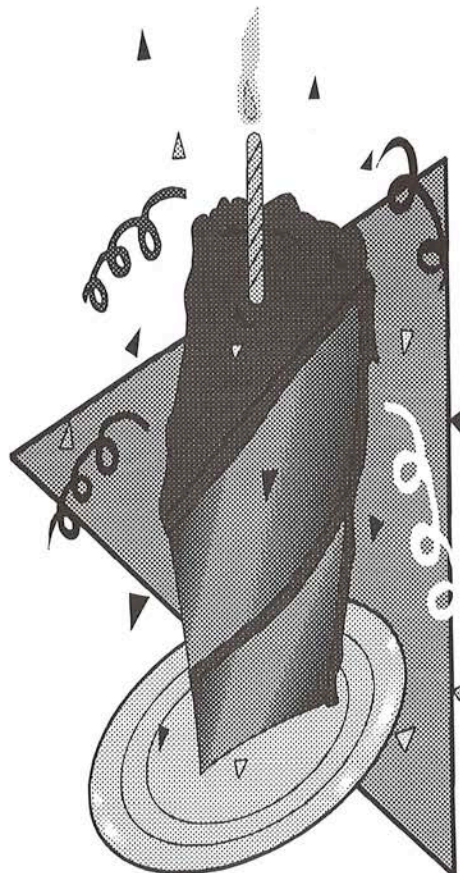

- 19 Brian Androw '81
- 27 Matthew Goodstein '83
- 31 James McGovern '84

April

- 2 Ronjon Datta '81
- 5 Daniel Rosen '83
- 7 Kei Kato '81
- Oren Jacobson '82
- Joel Sorinsky '82
- 8 Matt Cohen '81
- 13 Adam Kaplan '82
- 15 Andy Slusser '82
- 16 Matthew Gross '81
- Isaac Klein '94
- Marty Weisman '83
- 19 Brad Brook '81
- Herbie Lukes '81
- 22 Leonard Fialho '80
- Tom Budasz '81
- 24 Andy Schimel '80
- 25 Jeff Hood '79
- 26 Aaron Perna '80
- 29 Ethan Horowitz '82
- Jeffrey Stein '83

May

- 1 Evan Herman '81
- Brian White '82
- 2 Brad Mendel '82
- 3 Gabe Polsky '79
- Judah Klein '88
- 4 Enrique Lona '80
- 8 Ricky Kirsch '80
- 9 Jeremy Frydman '78
- 11 Trevor Abramson '81
- 12 Ross Edwards '81
- 14 Matt Passen '79
- Brett Pessis '83
- 16 Evan Harris '82
- 19 Scott Kaplan '81
- 26 Jonathan Walton '83
- 30 Andrew Draft '84

June

- 3 Nick Houchens '80

- Joe Rosenbaum '81
- 4 Jake Meilach '82
- 5 Elliot Pessis '80
- 6 Harley Rosenthal '81
- 8 Jamey Stengel '82
- 11 Jason Kummer '82
- 16 Jay Gustafson '83
- Jon Siegel '83
- 22 Jesse Latorre '85
- 27 George Burden '82
- 29 Michael Mason '80

July

- 4 Enrique Ojeda '80
- 5 Harris Kealey '84
- 7 Michael Hertz '83
- Sam Yuspeh '83
- 8 Brandon Levy '82
- 10 Sim Darwick '81
- 14 Stephen Goler '82
- 15 Adam Weingarten '83
- 16 Brian Zaander '82
- 17 Jose Basagoiti '80
- Keanan Levant '82
- 19 Reid Bartha '79
- 22 Casey Hintz '82
- Michael Hirsch '82
- 24 Philippe Ifergan '80
- 25 Aaron Eagle '78
- 27 Jeremy Emer '84
- 28 Jon Japha '80
- 28 Scott Schaff '83
- 29 Todd Block '80
- 30 Jake Goldner '80
- Todd Schwartz '81

August

- 6 Brandon Smith '80
- Tommy Nutter '82
- 13 Brian Andalman '80
- Jeff J. Davidson '83
- 16 David Cherner '80
- 23 Joe Jackson '79
- 24 Andrew Bender '81
- 25 Bradley Ross '83

September

- 3 Michael Weiner '82
- 10 Justin Jacobson '81
- 12 Matthew Weiss '80
- 16 Matt Frank '81
- 18 Eric Israel '83
- 24 Danny Levy '81
- Jeremy Matimore '83
- 27 Jake Neiman '81
- 28 David Schwartz '82

- 29 Seth Rheingruber '81
- Todd Rheingruber '81

October

- 1 Brandon Davis '83
- 2 Rob Kohen '84
- 3 Manuel Escalante '80
- 10 Chris Dickey '82
- 12 Eli Platt '82
- 19 Matthew Schwartz '84
- 23 Brian Teppis '81
- 25 Brian Summers '82
- 26 Stephen Stein '81
- 28 Brett Rheingruber '83
- 29 Zack Weiner '81
- Josh Zemel '84
- 30 Steven Katz '79

November

- 3 Ross Sider '80
- Eric Stang '84
- 4 Alex Yuspeh '80
- 5 James Dickey '80
- 14 Philip Sternhell '78
- Brett Chetek '81
- 15 Hannah Joy Klein '90
- 16 Javier Basagoiti '82
- Joshua Heller '83
- 21 Jordan Gaule '81
- 23 Ted Roth '80
- 24 Jordan Grant '81
- 30 Adam Greenberg '83

December

- 1 Matt Finder '81
- 2 Peter Bernick '81
- Evan Rosenberg '93
- 4 Bryan Simkin '80
- Mike Mesirov '81
- Nicholas Talbot '82
- 6 Anders Johnson '80
- Johnny Schatz '80
- 7 Josh Kurzman '82
- 10 Christopher Cady '80
- 12 Larry Miller '80
- Barry Schwartz '80
- 16 J.D. McCormick '83
- 17 Elliot Lieberman '82
- Jarret Turbin '82
- 18 Jonathan Feldman '81
- 20 Reed Edwards '79
- 25 Justin Clouse '83
- 29 David Lezak '79

Super Happy Birthday Camper To You!—Whoo!! Birthdays

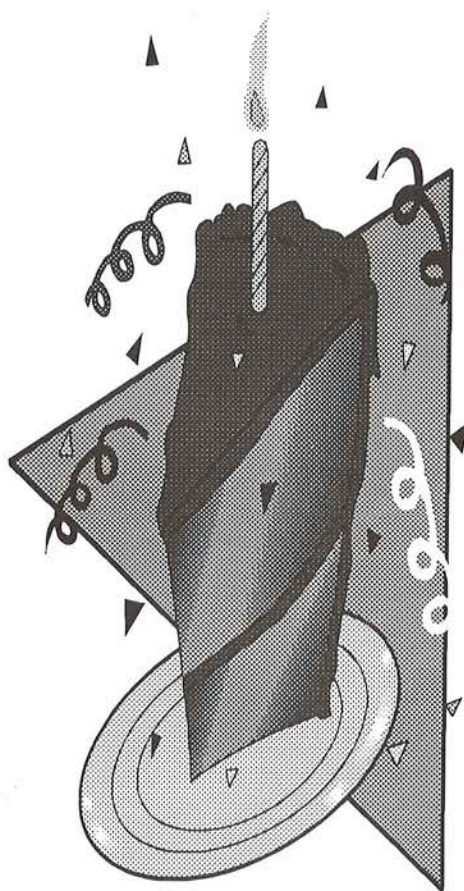

1994 Menominee Campers -

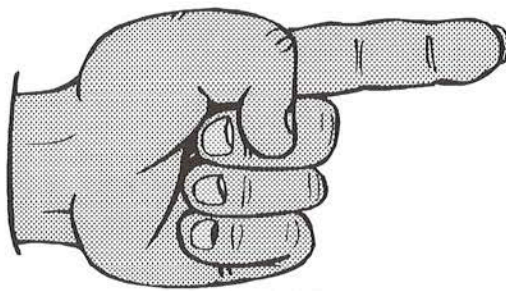

STAY IN TOUCH!

TREVOR ABRAMSON
1312 Mill Creek Drive
Buffalo Grove, IL 60089
708-255-0642

BRAIN ANDALMAN
1725 Summit Court E
Deerfield, IL 60015
708-945-8384

BRAIN ANDROW
3648 Torrey Pines
Northbrook, IL 60062
708-564-8967

ANDRES ARAIZA
Riviera De Cupia, 110-17
Residencial La Loma 11000
MEXICO DF
95525111891

REID BARTHA
720 Thornmeadow Road
Riverwoods, IL 60015
708-948-0992

JAVIER BASAGOITI
Riviera De Cupia 110-32
Mexico D.F. 11000
MEXICO
115252515767

JOSE BASAGOITI
Riviera De Cupia 110-32
Mexico D.F. 11000
MEXICO
115252515767

ANDREW BENDER
1809 Cloverdale
Highland Park, IL 60035
708-831-3133

JOSHUA BENJAMIN
1460 Country Lane
Deerfield, IL 60015
708-940-0482

MATT BERCOVITZ
1238 Franklin
River Forest, IL 60305
708-366-0711

PETER BERNICK
909 Ashland Avenue
River Forest, IL 60305
708-771-1818

TODD BLOCK
2700 Quail Lane
Northbrook, IL 60062
708-564-5818

BRAD BROOK
3605 Palm Canyon Drive
Northbrook, IL 60062
708-564-4481

TOM BUDASZ
2881 Landwehr
Northbrook, IL 60062
708-480-1647

GEORGE BURDEN
415 Harrison Street
Neenah, WI 54956
414-751-3661

CHRISTOPHER CADY
702 East Monroe Avenue
St. Louis, MO 63122
314-966-2868

DAVID CHERNER
9800 28th Avenue North
Plymouth, MN 55441
612-545-5889

BRETT CHETEK
827 Kimballwood Lane
Highland Park, IL 60035
708-433-1823

JUSTIN CLOUSE
200 South Vine Avenue
Marshfield, WI 54449
715-387-6572

MATT COHEN
4203 Ridgeland Lane
Northbrook, IL 60062
708-272-7838

SIM DARWICK
5 Tarry Hill Road
Tarrytown, NY 10591
914-631-3422

RONJON DATTA
429 Popolar Street
Winnetka, IL 60093
708-441-0849

DAVID DAVIDSON
140 Belle
Highland Park, IL 60035
708-926-0140

JEFF DAVIDSON
511 Sunset Lane
Glencoe, IL 60022
708-835-4047

JEFF J. DAVIDSON
140 Belle
Highland Park, IL 60035
708-926-0140

BRANDON DAVIS
1925 Watercress Way
Highland Park, IL 60035
708-433-3786

CHRIS DICKEY
1407 Redwood Forest Drive
Manchester, MO 63021
314-227-4387

JAMES DICKEY
1407 Redwood Forest Drive
Manchester, MO 63021
314-227-4387

ANDREW DRAFT
2333 North Racine
Chicago, IL 60614
312-935-0994

JEFF DRITZ
4305 Terri-Lyn
Northbrook, IL 60062
708-291-9686

AARON EAGLE
6725 North Campbell
Chicago, IL 60645
312-973-6255

DREW EDWARDS
1133 Sherwood Road
Glenview, IL 60025
708-998-0632

REED EDWARDS
1133 Sherwood Road
Glenview, IL 60025
708-998-0632

ROSS EDWARDS
1133 Sherwood Road
Glenview, IL 60025
708-998-0632

PETER EHRLICH
5653 South Fulton Way
Englewood, CO 80111
303-742-0060

JEREMY EMER
2801 Acacia Terrace
Buffalo Grove, IL 60089
708-634-3531

STUART EMMERMAN
24 Longmeadow
Winnetka, IL 60093
708-446-9077

MANUEL ESCALANTE
Av. Lovas Anahuac #121-8
Mexico 52760
MEXICO
5898205

JONATHAN FELDMAN
901 Baldwin
Highland Park, IL 60035
708-432-6372

LEONARD FIALHO
R. Emb. Carlos Taylor, 95 BL. I
Rio De Janeiro RJ, 22451080
BRAZIL
21511-3354

MATT FINDER
1341 Carlisle Place
Deerfield, IL 60015
708-940-1729

MATT FRANK
3614 Radcliffe Drive
Northbrook, IL 60062
708-564-9275

JEREMY FRYDMAN
6725 North Campbell
Chicago, IL 60645
312-973-6255

JORDAN GAULE
3728 Riviera Court
Northbrook, IL 60062
708-564-3728

JEREMY GLAZMAN
1044 Wayne
Deerfield, IL 60015
708-940-8911

JORDAN GOLDFARB
803 Highland Grove Drive
Buffalo Grove, IL 60089
708-459-5888

BRETT GOLDNER
40 Maple Hill Road
Glencoe, IL 60022
708-835-1722

JAKE GOLDNER
70 Maple Hill Road
Glencoe, IL 60022
708-835-1722

STEPHEN GOLER
1240 West Park Avenue, #313
Highland Park, IL 60035
708-433-7788

BOBBY GOODMAN
3 Rockgate Lane
Glencoe, IL 60022
708-835-4166

MATTHEW GOODSTEIN
116 East St. Andrews Lane
Deerfield, IL 60015
708-945-1817

JORDAN GRANT
91 Mary Street
Winnetka, IL 60093
708-835-8091

ADAM GREENBERG
2124 Tennyson Lane
Highland Park, IL 60035
708-831-9223

MATTHEW GROSS
3657 Palm Canyon
Northbrook, IL 60062
708-564-5863

JAY GUSTAFSON
517 Appletree Lane
Deerfield, IL 60015
708-940-8515

EVAN HARRIS
42 Tarry Hill Road
Tarrytown, NY 10591
914-949-2298

JOSHUA HELLER
2164 Tennyson Lane
Highland Park, IL 60035
708-831-2874

EVAN HERMAN
1595 Little John Court
Highland Park, IL 60035
708-831-4799

RENE HERTSBERG
312 Brookside Lane
Glencoe, IL 60022
708-835-0874

JEFFREY HERTZ
1407 Bayberry Lane
Deerfield, IL 60015
708-940-9484

MICHAEL HERTZ
1407 Bayberry Lane
Deerfield, IL 60015
708-940-9484

CASEY HINTZ
11988 Dalton Avenue SE
Delano, MN 55328
612-955-3001

MICHAEL HIRSCH
2417 Indian Ridge Drive
Glenview, IL 60025
708-564-4372

MATTHEW HOLLANDER
98 Marquette Road
Highland Park, IL 60035
708-433-9098

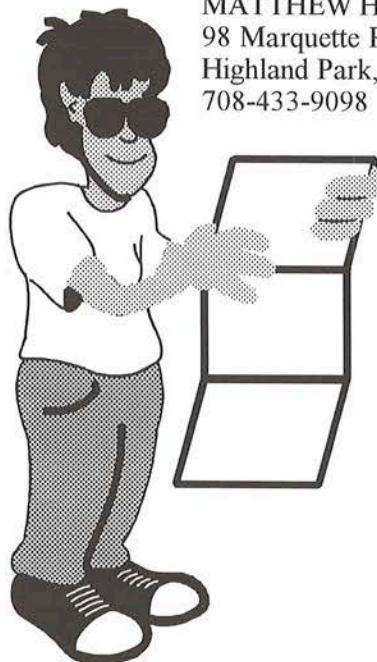

RYAN HOLZ
3723 Pebble Beach Road
Northbrook, IL 60062
708-498-0424

JEFF HOOD
13042 Huntercreek Road
Des Peres, MO 63131
314-966-5459

JASON HORN
3 Buckingham Place
Lincolnshire, IL 60069
708-374-0130

ETHAN HOROWITZ
1010 Elmwood Avenue
Wilmette, IL 60091
708-251-0501

JUSTIN HOROWITZ
10 Court of Stone Creek
Northbrook, IL 60062
708-498-9151

NICK HOUCHENS
5164 South Jamaica Way
Englewood, CO 80111
303-796-7360

PHILIPPE IFERGAN
1300 North Sutton Place
Chicago, IL 60610
312-943-5803

ERIC ISRAEL
1920 Greenview
Northbrook, IL 60062
708-498-6192

JOE JACKSON
6725 North Campbell
Chicago, IL 60645
312-973-6255

JOHN PATRICK JACOBS
2308 Indian Ridge Drive
Glenview, IL 60025
708-205-0333

JUSTIN JACOBSON
1332 Horizon Lane
Northbrook, IL 60062
708-564-1517

OREN JACOBSON
2215 White Oak Drive
Northbrook, IL 60062
708-272-9421

JON JAPHA
5630 South Big Canyon Drive
Greenwood Village, CO 80111
303-721-7797

ANDERS JOHNSON
5728 South Dorchester
Chicago, IL 60637
312-493-8211

ADAM KAPLAN
2008 North Mohawk
Chicago, IL 60614
312-787-9837

SCOTT KAPLAN
681 Aberdeen Lane
Buffalo Grove, IL 60089
708-541-2280

KEI KATO
3628 Torrey Pines Prkway
Northbrook, IL 60062
708-559-1695

STEVEN KATZ
670 Wicklow Lane
Deerfield, IL 60015
708-940-7892

MATT KAUFMAN
704 South Patton
Buffalo Grove, IL 60089
708-956-1612

HARRIS KEALEY
639 West Fullerton Parkway
Chicago, IL 60614
312-348-1881

RICKY KIRSCH
1227 Cambridge Court
Highland Park, IL 60035
708-432-5712

JACOB KLEIN
2756 Villa Ruhe
Marshfield, WI 54449
715-387-2267

JOSEPH KLEIN
2756 Villa Ruhe
Marshfield, WI 54449
715-387-2267

JUDAH KLEIN
2756 Villa Ruhe
Marshfield, WI 54449
715-387-2267

MATTHEW KLEIN
1069 Andean Place
Highland Park, IL 60035
708-831-5731

ROB KOHEN
626 Warbler Circle
Highland Park, IL 60035
708-433-4644

DAVID KRAUT
1026 Juniper Terrace
Glenview, IL 60025
708-998-1178

JASON KUMMER
4113 Rousseau Lane
Palos Verdes, CA 90274
310-541-7179

JOSH KURZMAN
1829 North Larrabee
Chicago, IL 60614
312-664-5546

JESSE LATORRE
8704 Ivy Avenue
St. Louis, MO 63123
314-638-0778



KEANAN LEVANT
1014 West Altgeld
Chicago, IL 60614
312-348-8133

J.D. McCORMICK
631 West Fullerton
Chicago, IL 60614
312-935-2232

TOMMY NUTTER
2474 Brixton Road
Columbus, OH 43221
614-488-8411

DOUG LEVIN
1660 Friar Tuck Avenue
Highland Park, IL 60035
708-831-4798

JAMES McGOVERN
305 West Madison Avenue
Milton, WI 53563
608-868-9883

ENRIQUE OJEDA
Monte Caucaso 945
Lomas De Chapultepec 11000 DF
MEXICO
5255206816

BRANDON LEVY
1916 North Mohawk
Chicago, IL 60614
312-642-0179

JAKE MEILACH
24 Graymoor Lane
Olympia Fields, IL 60461
708-481-7721

JARED OLIAN
2810 Lexington
Highland Park, IL 60035
708-433-5112

DANNY LEVY
180 Linden Park Place
Highland Park, IL 60035
708-432-7473

BRAD MENDEL
958 Suffield Terrace
Northbrook, IL 60062
708-272-2687

MATT PASSEN
1057 Eastwood
Glencoe, IL 60022
708-835-1361

DAVID LEZAK
1520 Lori-Lyn Lane
Northbrook, IL 60062
708-272-3076

JOSH MERSEFELDER
5407 South Fulton Court
Englewood, CO 80111
303-779-1463

AARON PERNA
6725 North Campbell
Chicago, IL 60645
312-973-6255

ELLIOT LIEBERMAN
1530 N. Dearborn Pkwy. Apt. 2N
Chicago, IL 60610
312-951-8199

MIKE MESIROW
72 Graymoor Lane
Olympia Fields, IL 60461
708-748-7411

BRETT PESSIS
370 Carriage Way
Deerfield, IL 60015
708-945-5187

ENRIQUE LONA
29 Sur 3910-5 Rincon Animas
Puebla, Puebla 72400
MEXICO
5222372684

LARRY MILLER
444 West Fullerton #808
Chicago, IL 60614
312-935-7036

ELLIOT PESSIS
370 Carriage Way
Deerfield, IL 60015
708-945-5187

HERBIE LUKES
765 Broadview Avenue
Highland Park, IL 60035
708-432-6984

BRAD MOSS
1200 Hidden Lake Drive
Buffalo Grove, IL 60089
708-913-0434

ELI PLATT
1650 Cloverdale Avenue
Highland Park, IL 60035
708-831-3653

MICHAEL MASON
584 Fairway View Drive
Wheeling, IL 60090
708-215-6024

JAKE NEIMAN
590 Carriage Way
Deerfield, IL 60015
708-948-5776

GABE POLSKY
770 Sheridan Road
Glencoe, IL 60022
708-835-3796

JEREMY MATIMORE
2035 Heather Terrace
Northfield, IL 60093
708-441-5390

JUSTIN MATIMORE
2035 Heather Terrace
Northfield, IL 60093
708-441-5390

PABLO MAYO
M. Cervantes 245
Mexico DF 11520
MEXICO
5253736426

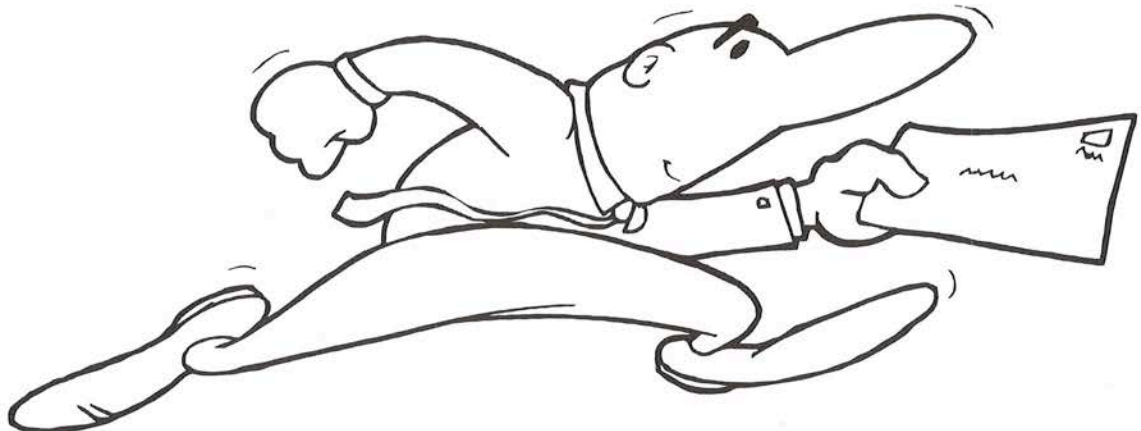

JARED RALSKY
2665 Priscilla Avenue
Highland Park, IL 60035
708-433-5282

CRAIG RASHKOW
1250 North Dearborn, #15C
Chicago, IL 60610
312-587-8766

MICHAEL REICH
2830 Woodmere Court
Northbrook, IL 60062
708-272-4057

BRETT RHEINGRUBER
1888 Eastwood
Highland Park, IL 60035
708-831-2264

SETH RHEINGRUBER
1888 Eastwood
Highland Park, IL 60035
708-831-2264

TODD RHEINGRUBER
1888 Eastwood
Highland Park, IL 60035
708-831-2264

DANIEL ROSEN
3065 Parkside Drive
Highland Park, IL 60035
708-432-4780

JOE ROSENBAUM
396 Bloom Street
Highland Park, IL 60035
708-432-9299

EVAN ROSENBERG
14056 Montrachet
Chesterfield, MO 63017
314-227-4907

HARLEY ROSENTHAL
1334 Laurel Avenue
Deerfield, IL 60015
708-945-7207

BRADLEY ROSS
7844 North Boyd Way
Fox Point, WI 53217
414-352-9029

TED ROTH
852 Sumac Road
Highland Park, IL 60035
708-831-4774

JORDAN ROTHSTEIN
1181 Furlong Drive
Libertyville, IL 60048
708-367-7954

MATT ROTHSTEIN
1181 Furlong Drive
Libertyville, IL 60048
708-367-7954

SCOTT SCHAFF
1791 Cavell
Highland Park, IL 60035
708-831-9686

JOHNNY SCHATZ
2145 North Clark
Chicago, IL 60614
312-327-6595

ANDY SCHIMEL
3706 Pebble Beach
Northbrook, IL 60062
708-564-4112

ADAM SCHREIER
385 Shenandoah Court
Deerfield, IL 60015
708-948-5845

BARRY SCHWARTZ
1212 Eaton Court
Highland Park, IL 60035
708-433-5828

DAVID SCHWARTZ
1212 Eaton Court
Highland Park, IL 60035
708-433-5828

MATTHEW SCHWARTZ
2790 Priscilla Avenue
Highland Park, IL 60035
708-432-6037

TODD SCHWARTZ
925 Bermuda Dunes
Northbrook, IL 60062
708-498-3511

ROSS SIDER
4115 Miller Drive
Glenview, IL 60025
708-564-2323

JON SIEGEL
3063 Centennial
Highland Park, IL 60035
708-433-6048

BRYAN SIMKIN
1600 Lancelot
Highland Park, IL 60035
708-831-4099

ANDY SLUSSER
6725 North Campbell
Chicago, IL 60645
312-973-6255

BRANDON SMITH
1023 Ashland
River Forest, IL 60305
708-771-3443

JOEL SORINSKY
3640 Torrey Pines Parkway
Northbrook, IL 60062
708-564-4264

MICHAEL SOLOVY
1322 Green Knolls Drive
Buffalo Grove, IL 60089
708-634-1781

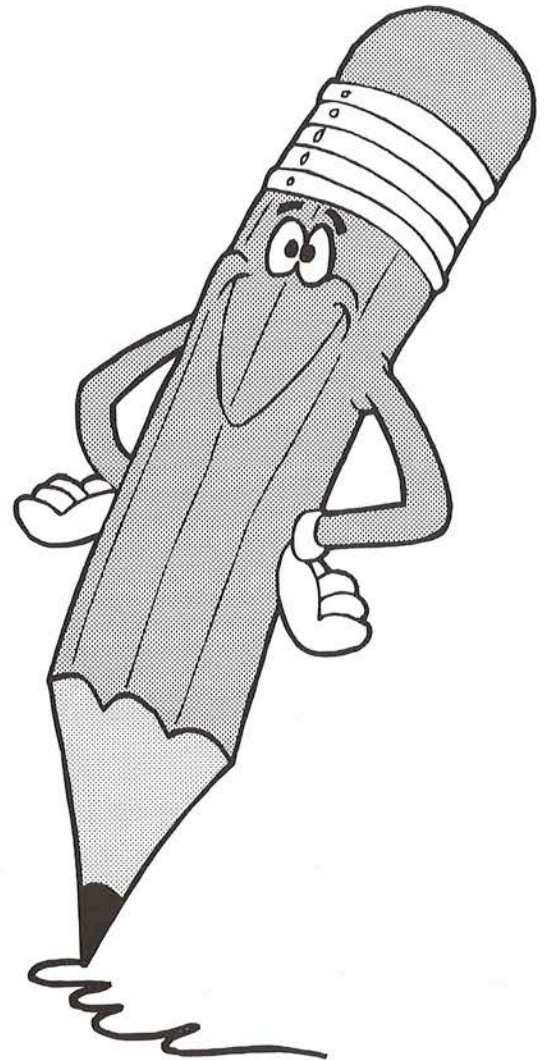

ERIC STANG
584 Hyacinth Place
Highland Park, IL 60035
708-432-2068

JONATHAN WALTON
1366 North Dearborn
Chicago, IL 60610
312-943-4850

ALEX STEIN
427 Stonemont Drive
Ft. Lauderdale, FL 33326
305-389-1961

COLIN WEINER
1829 Kathlin Drive
Iowa City, IA 52246
319-354-9068

JEFFREY STEIN
427 Stonemont Drive
Ft. Lauderdale, FL 33326
305-389-1961

MICHAEL WEINER
284 Ridge Road
Highland Park, IL 60035
708-831-4401

STEPHEN STEIN
427 Stonemont Drive
Ft. Lauderdale, FL 33326
305-389-1961

ZACK WEINER
54 Meadowview Drive
Winnetka, IL 60093
708-446-4408

JAMEY STENGEL
1051 West Columbia
Chicago, IL 60626
312-274-6416

ADAM WEINGARTEN
723 Mallard Court
Deerfield, IL 60015
708-459-8108

PHILIP STERNHELL
13803 Wellington Manor Court
Chesterfield, MO 63017
314-469-2213

MARTY WEISMAN
830 West Oakdale
Chicago, IL 60657
312-477-7180

BRIAN SUMERS
233 East Walton
Chicago, IL 60611
312-337-0970

MATTHEW WEISS
10438 East Weaver Circle
Englewood, CO 80111
303-220-7657

COLIN TAHI
500 Roscoe
Chicago, IL 60657
312-477-6219

BRIAN WHITE
333 Green Bay Road
Highland Park, IL 60035
708-433-4649

NICHOLAS TALBOT
74 Central Avenue
Highland Park, IL 60035
708-433-1924

ALEX YUSPEH
7400 North River Road
River Hills, WI 53217
414-351-2625

BRIAN TEPPS
1697 Colonial Lane
Northfield, IL 60093
708-441-5061

SAM YUSPEH
7400 North River Road
River Hills, WI 53217
414-351-2625

JARRET TURBIN
8425 Christiana #2
Skokie, IL 60076
708-679-7576

BRIAN ZAANDER
826 North Kenilworth
Oak Park, IL 60302
708-848-5518

JOSE VILLAVICENCIO
Escondida 114 LomasDe La
Herra Dura
HuixQuiLucan 52785
MEXICO
5252940848

JOSH ZEMEL
2785 Greenwood
Highland Park, IL 60035
708-433-2385

